

☐ OPEN AIR ☐  
**POULTRY HOUSES**  
**FOR ALL CLIMATES**



SF486  
W7

*By*  
PRINCE T. WOODS, M.D.

# The D. H. Hill Library

North Carolina State  
College



**This book was presented by**  
Animal Industry Dept.  
SF486  
W7

RY

UNIVERSITY OF NORTH CAROLINA LIBRARY



S00119510 H

87286

This book may be kept out **TWO WEEKS ONLY**, and is subject to a fine of **FIVE CENTS** a day thereafter. It is due on the day indicated below:

ANIMAL

23 Apr 58

12 Sep 58

19 Nov 58 E

8 Aug '62 Z

~~OCT 20 1958~~

NOV 24 1982

OCT 19 1983

ILL CA  
1071-86  
✓

JUN 10 1987

NOV 07 1996  
NOV 04 1998  
NOV 02 2001





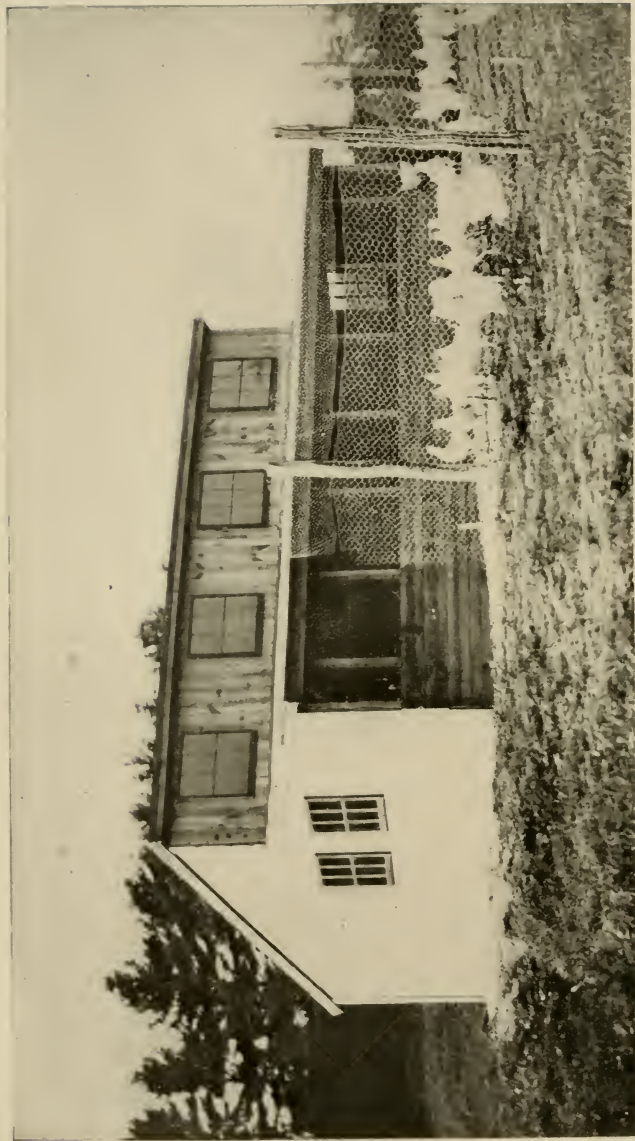

View of house from southwest, showing the large colony type of Dr. Woods' open-air house as built at The Anchorage Farm, Silver Lake, Mass. This house is 20 x 20 feet and furnished accommodation for 150 April hatched White Plymouth Rocks. (Photo August, 1911, by Dr. Woods.)

*“God lent His creatures light and air, and waters open to the skies;  
Man locks him in a stifling lair and wonders why his brother dies.”*

*—Dr. Oliver Wendell Holmes.*





# OPEN-AIR POULTRY HOUSES FOR ALL CLIMATES

A PRACTICAL BOOK ON MODERN COMMON SENSE POULTRY HOUSING FOR  
BEGINNERS AND VETERANS IN POULTRY KEEPING. WHAT TO BUILD  
AND HOW TO DO IT. HOUSES THAT WILL PROMOTE  
HEALTH, VIGOR AND VITALITY IN LAYING AND  
BREEDING STOCK.

BY PRINCE T. WOODS, M. D.  
MANAGING EDITOR AMERICAN POULTRY JOURNAL

PUBLISHED BY  
AMERICAN POULTRY JOURNAL PUBLISHING CO.  
CHICAGO, ILLINOIS  
1912

COPYRIGHT, 1912, BY  
AMERICAN POULTRY JOURNAL PUB. CO.  
ALL RIGHTS RESERVED

## FOREWORD



HIS BOOK was written, and the illustrations made, for the purpose of supplying an ever increasing demand for plans and building instructions of the best and most practical modern open-front open-air, or "fresh-air poultry houses."

The fresh-air or open-air idea is not wholly new. We have had a few advocates of open-air housing for poultry since the earliest history of domestic poultry, but general promotion of open-air or "fresh-air" methods has only been developed during the past decade. The doctrine of fresh air has been so successfully preached that we now find open-front poultry buildings affording comfort for fowls all over the American Continent in localities where a few years ago open-front houses were not known. I firmly believe that the general adoption of open-front houses for poultry in cold and temperate climates and in hot climates where long, chilling rains are prevalent, and of cage roosts for hot or warm climates that are not subject to frequent heavy rains, will result in a decided improvement in the health, vigor and vitality of domestic poultry.

Building plans are given for Woods' Improved Open-Air Poultry House, designed and built by the author; the Gillette Open-Air House, designed by George K. Gillette, manager Sugar Brook Poultry Farm Co., Central Village, Conn.; The Stoddard Open-Air Cage Roost, designed by H. H. Stoddard, Riviera, Texas, for warm or hot dry climates. Illustrations from photographs of the Tolman Fresh-Air House are also given, but plans and building instructions are omitted, as such are subject to the copyright of the inventor. Joseph Tolman, of Rockland, Mass.

This volume will have fulfilled its mission if it serves to create a greater interest in open-air poultry housing and the building of more practical open-air quarters throughout the land, thus insuring greater comfort and greater constitutional vigor for the fowls and better returns for the poultry keeper.

Silver Lake, Mass., 1912.

PRINCE T. WOODS, M. D.

87286



# CONTENTS

CHAPTER I—SUNLIGHT AND FRESH AIR.....	11
Importance of pure open air both day and night for all domestic poultry—Relation of sunlight and fresh air to health and vitality—Nature's best aid in the prevention of diseases.	
CHAPTER II—WHY USE OPEN-FRONT HOUSES.....	17
A few more reasons why you should use open-front open-air houses for the comfort and well being of your fowls, as well as for the betterment of your profits.	
CHAPTER III—HINTS AND HELPS ON BUILDING .....	31
Tools and experience required—Materials—Suggestions for saving cost, floors, frame, eaves, shingles or roofing—Portable or permanent buildings—Foundations.	
CHAPTER IV—LOCATION OF POULTRY HOUSES.....	39
Land—How to face the building—Relation to surrounding country—Prevailing winds and wind breaks—Continuous or colony buildings—Yards.	
CHAPTER V—DR. P. T. WOODS' IMPROVED OPEN-AIR POULTRY HOUSE.	45
Photographic building plans showing actual construction—Dimensions of buildings—Suggestions for building on colony or continuous plan—Building instructions and list of material required for house to be boarded up and down.	
CHAPTER VI—ANOTHER PLAN FOR DR. WOODS' HOUSE.....	59
Line drawings showing plans and detail of frame—House to be boarded horizontally—List of material required.	
CHAPTER VII—THE GILLETTE OPEN-AIR HOUSE.....	67
The house used in International Laying Competition—Description, plans and list of material required.	
CHAPTER VIII—H. H. STODDARD'S OPEN-AIR CAGE ROOST.....	75
A protected outdoor roost for fowls in warm or hot dry climates, where no houses are needed—Diagrams showing two types of cage roosts—Night quarters, which help solve the stickfast flea problem, and afford greater comfort for fowls in tropical and semi-tropical climates—Rain tight roof may be provided where frequent heavy rains prevail.	
CHAPTER IX—THE TOLMAN HOUSE.....	81
Brief description and some views of this pioneer among modern "fresh-air" houses.	



## CHAPTER I.

### Sunlight and Fresh Air



SUNLIGHT and pure fresh open air are two of the greatest and best gifts which the Creator has loaned to all things on this wonderful earth of ours. Yet, because both sunlight and fresh air are free and easily obtainable they are seldom appreciated at their full value. As a rule, and as a people, we seldom appreciate anything until we have paid dearly for it in money or experience, or both. Poultry keepers everywhere have paid dearly through failure to appreciate the value of sunlight and fresh air.

Today we are just beginning to realize the great menace of "germ diseases" among poultry. What we need is *more attention to prevention* and less fussing with treatments, remedies and "cures." That great American master mind, Edison, tells us that: "The unicellular (one celled) forms of life held undisputed sway for ages. Then gradually the multicellular (many celled) forms, of which man is the highest product, developed, and the unicellular forms at once sought their destruction. And so through all the ages the fight has gone on, and today our deadliest enemies are still the minute unicellular bacteria, that do their work unseen, and by the majority of the people in the world unheard of."

Just bear that in mind and remember that disease germs belong to the unicellular army and that some day we are going to eliminate them, and that, notwithstanding the great strides made by medicine and the science of reclaiming diseased bodies, *prevention* will be the means of elimination, and *sunlight*, combined with *pure open air all the time*, will be two of our most powerful agents in bringing the battle to a successful issue.

That distinguished physician and talented author, Dr. Oliver Wendell Holmes, was an ardent advocate for the more general recognition of the priceless value of fresh air and sunshine. In one of his poems he aptly illustrates how blind man is to the benefits of these great agents for maintaining health and vitality. Dr. Holmes wrote:

"God lent his creatures light and air, and waters open to the skies;  
Man locks him in a stifling lair and wonders why his brother dies."

That is just what many poultrymen have been doing for years,—

locking their poultry "in a stifling lair," away from fresh air and lacking in sunlight; and then they wonder why poultry disease is common and fowls waste and die.

Nature never intended that fowls should be housed at all, but for our own protection and convenience we find it necessary to house them in some fashion. When fowls roosted in sheltering evergreen trees entirely out of doors they rarely became diseased, but also rarely laid eggs in winter, and they were easy prey for all two and four-legged thieves. Closed houses were the other extreme and the winter egg yield was increased, but with close housing came neglect of ventilation, or the careless introduction of cold drafts into a house full of confined stale or foul air, and this brought about debility, disease and death.

Fowls wear their outdoor clothing the year 'round and change it only at moulting time. Normally they moult in time to have a heavy coat of warm plumage before severe cold weather sets in. This coat is worn night and day; there are no outer garments to be laid aside on going indoors if the house is warm and close. The birds cannot open doors or windows at will and the attendant is always at a loss to know how to operate windows and ventilators and usually ends by leaving them closed. A closed house that has no heat is usually too warm on a sunny day and too cold and chill on cloudy days or at night. The cold is of the damp, chilling, penetrating sort that cuts to the very marrow. A closed house with heat is too warm and close at all times for adult fowls.

We all know the difference between working in an open shed in winter and working in a cold, tightly closed building. The open shed is by far the most comfortable, for the cold is "drier," the air is purer and more wholesome, and there is none of the depressing effect of the cold and chilling, stale, damp air. For the same reasons the open-front house is more comfortable for poultry than a closed house.

Admitting that the open-front house is more comfortable than a closed one, some poultrymen are still afraid to use it without curtains for fear of frosted combs and that storms will drive snow and rain into the building. These fears are not sustained by the facts shown in actual experience. Where cold, driving storms prevail, if the house is made tight as to roof, rear and side walls, if the open front is covered with  $\frac{3}{4}$ -inch mesh galvanized wire netting, and if the house is made sufficiently deep in proportion to the expanse of open front, storms will not drive in to any troublesome extent; there will be no danger of frosted combs under all ordinary conditions, and at all times less danger than in a closed house; and



curtains in the front of the house or in front of the roosts are both unnecessary and undesirable.

You are building an open-front house because you wish to have your fowls supplied with an abundance of pure, fresh air, day and night? All right, then; make it an open-front in fact, and don't offer a sop to your qualms and fears by stopping up the opening with cloth or burlap. The Woods house described in this book has been used successfully and with most satisfactory results in the deep snows and cold of British Columbia, in all parts of the United States, including bleak, cold and windy lake shore and seashore sections. When properly constructed it has proved a safe



View of north and west sides of Dr. P. T. Woods' Improved Open-air Poultry House as completed and ready for painting. Roof is covered with Amatite. (Photo by Dr. Woods.)

and comfortable poultry house and one that is economical and easy to build. It provides for ample sunlight where it is most needed, in both front and rear of the house, and it is sufficiently open in front to afford an abundance of pure open air day and night, with no discomfort to the fowls and no dangerous drafts about the roosts.

Sunlight and pure fresh open air are Nature's best preventives of disease, destroyers of dangerous germs, and promoters of health, vitality and comfort. Both sunlight and fresh air are necessary to the health and well being of our poultry and to obtaining the best

returns from them. You have only to properly try open-air methods to become convinced.

Everyone knows, or should know, that wholesome living things will not thrive without sunlight in sufficient quantity for their needs. If we lose sunlight for many days fungus growths and other unwholesome things become active; even the air becomes less satisfying and is oppressive, and unless the blessed sunlight puts in an appearance soon, and for a sufficiently long interval to do its beneficent work, we find disease developing rapidly. We, our poultry and all other living creatures, must have sunlight to supply us with energy and many useful elements which the light brings to us. Everyone knows, too, or should know, that mankind is better for much open air living. The same is true of our poultry to even a greater extent. They need an abundance of pure, fresh, open air to breathe day and night, and particularly at night. The fowl's body has a normal temperature considerably higher than that of a human being. In proportion to its size the fowl undoubtedly consumes a considerably greater amount of the life-giving elements of breathing air. Nature built fowls to live in the open and they require pure open air for breathing purposes at all times.

Fowls go to bed early. They go to roost at dusk and do not leave the roost until daylight in the morning. They sleep longer hours than the average human being in summer and much longer hours in winter. Man's need of pure breathing air during sleep is greater than during his waking hours and the fowl's need is even greater.

Sleep is a recuperative process, it is Nature's method of helping to restore the proper balance of the body. During sleep the up-building processes within the body are considerably in excess of the breaking down processes, while during waking hours the conditions are reversed. Sleep and the restoration of bodily balance or building up of broken down tissues is necessary to life and health. Oxygen is necessary for the building up processes, and this oxygen is to be obtained from pure, fresh, open air. The foul, stale air of a closed house does not contain sufficient oxygen to provide for the normal upbuilding and it does contain poisonous exhalations that are dangerous to life and health. The open-front open-air house when properly built insures an abundance of life-giving fresh air at night, when it is most needed.

The total intake and outgo of oxygen for the twenty-four-hour day has not been figured out for fowls, but it has been determined approximately for human beings. Fowls require more oxygen in proportion to their size than do human beings, but the figures

which have been given will serve for purposes of illustration. During the twenty-four hours the average human body takes in during the twelve hours of daylight only about 40 per cent of the total amount of oxygen required and gives off about 60 per cent of carbon dioxide. During the twelve hours of night, mainly during sleep, some 60 per cent oxygen is taken in and only about 40 per cent carbon dioxide is given off. From this it will be seen that the



Interior view of F. M. Peasley's fresh-air house for 2,000 layers, Cheshire, Conn. Shows arrangement of track for feed car, hoppers, roosts, partitions, etc. (See page 64.)

body during the day gives up or gets rid of from 20 to 40 per cent more oxygen than it takes in, and during the night it takes in from 20 to 40 per cent more than it gives up. It may be urged that the amount of carbon dioxide (poisonous gas) given off at night is considerably less than by day, but bear in mind that the space occupied by a sleeping fowl at night is very much less than the space which it occupies through the day and that at night it remains in one place. Unless the fowl at night is abundantly supplied with pure, fresh breathing air, it has less chance of obtaining the neces-

sary oxygen than it has during the day and there is more danger of breathing over and over again the foul gases exhaled.

The reader may think that for a book on houses I have given considerable space to this chapter on sunlight and fresh air, but if it will serve to promote a more general use of actual open-front poultry buildings it will prove space well spent. I have had ten years' experience with open-front houses of various types, and prior to that had for many years used closed houses, curtain front houses and open sheds, as well as allowing some fowl to roost in the trees. From my own experience and from observing the results obtained by others and from reports of open-front house users all over the American Continent, I am convinced that the properly constructed open-front house is the only sane and sensible method of housing poultry in cold and temperate climates, and the entirely open, roofed, shelter or the cage roost is most desirable for warm and hot climates.

The importance of abundant sunlight and fresh air needs no further comment here. If poultry keepers everywhere would abandon the old type of closed poultry house and adopt a well constructed open-front house, or such form of roost, shelter or cage roost as is best adapted to their location and climate, and would breed and feed for health, there would be less poultry disease each year and in the years to come it might be eliminated. Open-air housing of laying and breeding stock and common-sense breeding and feeding for health will do more towards obtaining healthy poultry, fertile, hatchable eggs, and strong, sturdy chicks than all the systems, treatments and remedies ever invented.

Give the open-front house, with plenty of sunlight and fresh air, a fair trial, Mr. Doubter, and you, like others who came to scoff, will remain to pray.

## CHAPTER II.

### Why Use Open-front Houses



OW AND THEN someone asks the question: "Why use open-front houses?" That person has not used a fresh-air house and is either in doubt as to the desirability of such poultry quarters or is afraid to use an open-front building for poultry, fearing danger from cold and exposure. He only needs to give the right sort of an open-air house a good, fair trial to become convinced that the danger is all imaginary.

To be successful with poultry it is necessary to keep the fowls comfortable and they find comfort, real comfort, in a well planned house of the open-front type. The terms open-air and fresh-air house apply to the same type of building, i. e., one with a partly or entirely open south front.

An open-front house is not necessarily a very cold house; it is always warmer than the outdoor temperature and it is actually more comfortable than a similar closed building would be. A cold house, however, provided the south front is kept open, is no drawback to the production of an abundance of eggs in winter. Fowls actually lay better in open-front quarters in winter than they do in closed houses, and in climates where the temperature drops to 20 and even 40 degrees below zero.

Connecticut Agricultural College successfully wintered White Leghorns in tents and had a good egg yield, with no frozen combs and no sickness. Both Leghorns and S. C. Black Minorcas have been wintered for several years in Woods' open-air house in cold locations where temperature registered 10 below frequently, and 20 to 30 below zero several times, and excellent health, fine egg yield and no frosted combs was the report sent us. High winds and driving storms did not cause fowls any inconveniences or any check in egg production.

In 1908 Editor Miller Purvis said in November *Poultry*: "The open-front poultry house is making friends all the time. It keeps the fowls healthy, is cheap and more comfortable than the old-style house." There's the reason—it is "*more comfortable*." Anything that "keeps the fowls healthy" and affords them more comfort is sure to bring about better results and greater profits.

Prof. James E. Rice, of Cornell Agricultural College, in a lecture given several years ago said: "The open-air house has become a fixture in modern poultry husbandry. Without pure air in a poultry house a poultryman cannot stay long in the business, unless he has a large bank account to foot the bills. Hens will do far better in cold pure air than they will in warm impure air; fresh air is of more importance than warmth, if we cannot have both."

Now, let's consider a few more reasons why you should use open-front open-air houses for the comfort and well being of your fowls and to the betterment of your profits:

In the first place, an open-front of the best modern type will cost you less to build than a closed house that will house the same number of birds. It will be a better house and more attractive to look at. It should not cost you over \$1 per bird housed, at first cost, and it ought to last at least fifteen years without repairs other than touching up the paint about the windows.

You will have more healthy fowls and enjoy comparative freedom from all serious poultry ailments, and you will be able to keep more fowls on the same land.

Cooped up air, dust laden air, foul breathed out air, is everywhere in closed poultry coops and buildings, and it is always bad. Pure open air, circulating freely and comparatively dust free, can always be had in an open-front house, and it is always only good. Have an open-front house and so supply your fowls with always good air at all times.

You can keep 150 layers that will average six pounds each in an open-front house 20x20 ft. and get good results in health and egg yield. You *can* do it; it has been and is being done, but I prefer not over 100 layers in a house of that size. To house the same number in a closed building you would require double the floor space and would in all probability have much less satisfactory results and more worry and labor.

Contrary to the belief of some open-front poultry house users, large flocks are not necessary to the successful use of an open-front house. You don't have to fill the house up with birds to keep them warm; that isn't the idea at all. You can keep larger flocks in open-front houses than you can in closed houses of the same size and get better results. There is less danger from crowding fowls in an open-air house. If, for any reason, you wish to carry a small flock in a good sized open-air house you can do so with perfect safety and with good results. For two winters, both severe ones, I carried a little flock of special mating cock and four females in an open-front house 8x14 ft. and apparently they were

quite as comfortable as a flock of thirty birds in a house of same type and size, close by.

House sweating and dampness causes no trouble in properly built fresh-air houses. When built of boards covered with shingles, or with some of the graveled felt roofings, I have always found the houses dry and free from frosting. I have had several complaints of dampness and house sweating in open-front houses where the boards were covered with heavy, smooth, hard-finish roofing. This



Experimental Woods' Open-air House built in 1908 at Topsfield, Mass. This house has a double board floor and is set on posts over which large pans have been inverted to make the house rat proof. View shows south front and west side. (Photo by Dr. Woods.)

was probably the fault of the roofing used. In one other case the house was too low studded and roof boards were too close to the heads of the roosting fowls. An open-front house should have plenty of head room about the roosts.

Open-front open-air houses are *actually open* houses. The open portion of the south front *stays open night and day the year*

'round. There are no curtains of any kind. The only protection given to the opening in the south front is the overhang of the eaves and the screen of  $\frac{1}{4}$ -inch mesh galvanized wire netting. The screen is used over the opening to confine the fowls and to keep the small birds like sparrows out of the house. Being fine mesh screen it serves as sufficient protection from driving wind, rain and snow storms, and it is really surprising how little of a storm gets through the wire.

During the fall of 1911 we had one of the worst wind and rain storms Plymouth County, Massachusetts, has experienced for many years. It blew a howling gale from the south and west right off the pond and lake, damaged trees, and drove loose boards around like bits of paper, the wind blew the torrents of rain on a slant that was but little more than the horizontal and it literally washed the paint from the south front of the new barn. In spite of rubber clothing I was soaked to the skin going from my dwelling to the open-front poultry house, less than 100 yards away. Inside of the house, except for the noise of the wind and rain outside, one would not be aware of the fury of the storm. The wind could not be felt at all in the house at a distance of four feet from the open front. The fowls were comfortable and happy. A little water came in through the wire screen, but only a very little, and less than one yard of the floor immediately back of the wire front screen received a wetting. This house is the one shown in the illustrations from photographs showing construction of the Woods House.

It is less trouble to operate an open-front house than any other kind of poultry building. Being always open, there is no ventilation or ventilators, or opening and closing of windows to worry about. You can go to bed and sleep through hard storms and cold nights with no occasion for worry about the fowls or whether you should have left the windows or ventilators open or shut.

A dozen years ago there were very few open-front houses for poultry. A few poultrymen scattered over this great country have used open-front sheds and partly open poultry houses for many years, but such houses were not in anything like general use. Most "authorities" used and recommended the closed type of poultry house. Within the past twelve years open-front houses have been gaining enthusiastic admirers and advocates everywhere. All over the country you will find open-front open-air poultry quarters, of one type or another, that are giving most satisfactory results.

The open-front house has won its place on merit and it will



continue to hold it on merit. The merit of being the most sane, sensible and satisfactory method of housing domestic poultry. The experience of hundreds of users in extremely cold, temperate and warm climates, has demonstrated beyond question that open-front housing for poultry insures *constitutional vigor, better health, better egg yield, better fertility, more hatchable eggs, more and better chicks, greater vitality and better growth in young stock*, less danger from disease germs and comparative freedom from disease, therefore assuring *greater profits*.

Such houses are easy to care for and therefore make a saving in labor. For warm weather use the modern open-front house can be made still more open, affording sufficiently cool and comfortable quarters for the hot season. It is a house that is sufficiently warm in winter and cool enough in summer.

Tests made with an open-front house, 10x16 ft., in cold and bleak Saratoga County, New York, with S. C. Minorcas, gave most satisfactory results. With only fifteen fowls housed the inside temperature in center of house half-way between floor and roof stood at zero when temperature outside of the house registered 15 degrees below zero.

Progressive physicians all over the world are using open-air treatment as a means of preventing disease and as an aid in the cure of disease. Progressive poultrymen are learning that open-air housing will do the same for poultry, will help us to more and better poultry and to better returns and better profits.

Open-air housing has never yet killed a fowl, it has not injured one, it has helped and benefited every fowl properly cared for under open-air methods, it has made thousands of fowls more comfortable and has helped to prevent, check and cure disease in many forms. Why not make your flocks comfortable when it means so much and costs so little?

Don't be afraid of fresh air. Fowls don't "catch cold" from being allowed an abundance of pure, fresh, open air under conditions which are comfortable. They "catch cold" from breathing confined impure air which has been stirred up by thin cold drafts while the fowls are subjected to the discomfort of chilling and deadly, closed-in, damp, impure air.

While it is always advisable to start young birds in open-front quarters and to keep them in such, there is actually less danger in transferring birds from a closed house to an open-front one in cold weather than there is in changing them from one closed house to another or from an open-front house to a closed one. I have, on several occasions, taken sick fowls from a closed house in winter

with the temperature ranging from zero to as low as 40 degrees below zero F., and transferred them to small entirely open-front coops located on snow-covered ground, and have had all that were fit to live make a good recovery. This with no other treatment than open-air housing and liberal feeding. A few of the weakest will succumb and die under this treatment, but the losses have always been surprisingly few. Don't be afraid of fresh air. It is far better to lose a few sick or debilitated fowls from exposure (they would undoubtedly die anyway and are always a menace to the



Another view of Experimental Woods' Open-air House showing east side and south front. (Photo by Dr. Woods.)

flock) than to run the risk of losing the majority or all of the flock through allowing them to remain in closed quarters.

Some fanciers ask: "Is it safe to take fowls from the show room and place them in open-air quarters?" I believe that it is much safer than to return them to a closed house. There is always risk in washing and in shipping and exhibiting birds. To my mind it is safer to take a fowl from the shipping coop and place it in good open-air quarters than it is to take the chance of cooping it in closed house or coop. Most of the damage is done during transportation and in the show room. Fowls when washed must, of course, be dried in a well aired, warm room and should go from there

direct into the shipping coop. I would not place a recently washed bird in open-front quarters until it had had ample opportunity to dry off thoroughly and to get over the effects of its bath. It is simply a matter of common sense judgment.

Can small chicks be kept in open-front quarters? They can under the right conditions. Place suitable brooders in any open-front colony house in winter and run them as you would out of doors in the spring. Keep the little chicks comfortable and as soon as they are sufficiently well trained let them have the run of the house. Wean gradually and when too big for the brooder take it away and let them continue to occupy the house.

A successful Connecticut poultryman raises Leghorn chicks in cheap, home-made, lamp-heated, roofless box brooders; operated in cold weather in open-front sheds. It is sometimes so cold that it takes three lamps to keep the hover space warm enough, but the chicks are kept comfortable and thrive. He abandoned an unsatisfactory closed brooder house to use this plan, which has proved successful. It is not necessary to go to such extremes, but if he can raise strong chicks in such exposed hovers you need have no fear about growing them in a well constructed open-front house, provided you use a sensible brooder that admits an abundance of pure breathing air.

In 1910 Prof. W. R. Graham, Ontario Agricultural College, Guelph, Canada, said in an interview that he considered that: "To date the single-boarded, open-front house has proved superior for getting eggs in winter and keeping the fowls in a healthy state." Prof. Rice, of Cornell, in the same year, said: "Fresh air is one of the most important assets which we have for building up and maintaining bodily vigor. To get the best results the birds should be housed in open-air buildings."

Dinsmore & Co., Kramer, Indiana, use fresh-air houses, find them entirely satisfactory and a sick fowl is a rare thing on their plant. They favor the Woods type of open-front house.

U. R. Fishel, Hope, Indiana, recommends open-front houses, devotes several pages in his latest catalogue to a description of the improved Woods house and says: "I would suggest the building of Woods' Improved Open-front Poultry House, which I consider the best open-front poultry house built today."

A circular letter was sent out to representative poultrymen in the United States and Canada, asking what type of poultry house they preferred for best results—open-front or closed house. The majority were in favor of one or another type of open-front house and one breeder who is located where the temperature sometimes drops

to 40 degrees below zero in winter, said: "Woods' open-air colony poultry houses. We want fresh air night and day to insure health. This is a cold country in winter."

Bulletin No. 183, Maryland Agricultural Experiment Station, says:

"A few years ago the open-front poultry house was practically unknown. The tendency at that time was to construct houses that were very tight, and ventilated by the opening of windows, and in many instances by means of flues and cupolas. This type of house as a rule was more or less damp, and it did not take many years for progressive men to realize that damp houses meant cold houses and an abundance of disease. The result has been a gradual increase of the amount of fresh air in the house, and less attention given to warmth, until today we have what is known as the open or cloth front house. One can still find, however, many types of poultry houses, but the open-front house is fast becoming the standard for every climate.

"The beneficial effects of a dry house with an abundance of fresh air, has been very forcibly demonstrated by several Experiment Stations. \* \* \* The open-front house can be modified to meet a wide range of climate. \* \* \*

"In different parts of the state where new buildings are being erected, the open-front or fresh-air idea was in evidence. There is little doubt but that the open-front house is one big step toward putting the poultry industry on a firmer basis, and for houses of all sizes this type of house is strongly recommended."

Manager A. Carr, of the Milton Poultry Station, New Zealand, recommends the open-air system of housing and says:

"Owing to the continued increasing demand for breeding stock and sittings of eggs, I have been obliged to further increase the accommodation by altering a number of the original houses and adding the new type of cheap 'open-air houses.' These have proved a complete success in every way and prove beyond all question that the old style close and expensive house is quite unnecessary for the keeping of poultry for profit."

In the 1909 report of the Poultry Division of the New Zealand Department of Agriculture is the following:

"Experiments carried out at the Milton Station in the open-air system of housing have proved very satisfactory, and the system can now be recommended to poultry raisers in any part of the Dominion, no matter how severe the climate."

A successful user of open-front poultry houses refers to the old-fashioned type of closed house as a "roup factory."

H. H. Stoddard in *The Poultry World* for September, 1876, said:

"We cannot be over-mindful of the facts that clear fresh air continuously, pure clean water for drink, and untainted food and quarters, are highly promotive of the health of poultry, and at all seasons. But we are constrained again to affirm that of all these, pure air for them to breathe is of the first and last importance towards their continuous health and thrift."

In 1910, in a personal letter to the author, H. H. Stoddard wrote:

"Shake, Doctor! You are in it! I don't know whether you stop to pat yourself on the back very much or not, but it is fair to presume that it is pleasant for you to reflect that now, and for ages, thousands and millions and billions of pairs of lungs will push and pull a volume of fresh air, minus carbon dioxide, that will equal a volume of the atmosphere over an empire, and a wave of good hearty animal happiness will roll, like the British drumbeat encircling the earth and ceasing not so long as there is civilization and the keeping of domestic animals!

"I write with some ardor on this fresh air biz for reasons I will proceed to set down. For fifteen years or more I read nothing on poultry. Lost the run of things entirely. Then read R. P. J. files through 1909. Learned more of importance, I can truthfully say, from your pen than from all my previous reading of poultry books and papers put together.

"My interest in the anti-tuberculosis crusade, and the wonderful vigor imparted by the open windows o'nights practice to well people, made me read carefully your statements. I determined to open two big doors to my poultry house. Now, here is an important thing. The oldest residents (about fifty years is the limit since exclusive Pawnee occupation here in this part of Nebraska have never experienced so severe a winter. For six weeks the cold had no let-up. For twelve mornings in succession, by a very strange uniformity, my thermometer said 5 degrees below, almost to a hair. Previous to that, and afterwards, it was every morning from zero to 18 degrees below, in the whole six weeks period. My house doors stood open on the east and the perches were not way back from the opening. House, a barn really, so wide, long and high that animal heat couldn't warm it to amount to anything.

"I expected frozen combs would compel me to stop the experiment. Had very large, freezable combs. None froze! Birds very bright, active and healthy. Water left by mistake froze six inches in one night.

"A neighbor with new brick poultry house with stove and fire night and day. Very enthusiastic. No end of care. Fed fresh meat some, and variety of good things. Sat up late to tend fire.

"Educated, very intelligent and energetic young woman with Philo plant and 55 early well developed Wyandotte pullets raised by her in the plant. Tremendous lot of work put in.

"Good output of winter eggs in all three flocks. Stove man very slightly ahead. Philo lady and I 'nip and tuck.' But now see where I shine. My birds by long odds more vigorous than either of the other flocks. Philo lady ran a small hen hospital on the side. I had need of none. Half my number semi-tropical Leghorns.

"I came to scoff and remained to pray. I am converted and reformed. Thought I understood fowls. For nearly fifty years I have preached ventilation. Am through. No ventilation is necessary for a bird in a tree, or for fowls which have practically the same exposure to the outside air as their wild progenitors had in the trees."

Friend Reader, take a tip from Editor Stoddard, a man who knows poultry as probably no other living man on this green earth does, give the modern, practical open-front house a thorough and fair trial, forget your doubts and let experience convince you. Even if you, too, have come to scoff, you will remain to pray.

Secretary F. D. Coburn, of the Kansas State Board of Agriculture, says relative to poultry housing: "Pure air must be supplied at all times if the fowls are to do their best. Pure fresh air is a tonic—an invigorator—and will do more toward keeping the fowls healthy than all the nostrums ever invented. Whatever plan (of housing) is used, pure fresh air must be supplied. It is not a luxury, but a necessity—just as essential to thrift and health as food and water."

C. L. Opperman, instructor in poultry husbandry, says: "The perfection of the open-air house has made it possible to save almost one-half the cost over former construction, for it has been demonstrated that the health and productiveness of the flock is much better than when double-walled construction and various ventilating devices were in use."

Henry B. Prescott, practical poultryman, Derry, N. H., believes in fresh air for poultry of all ages. His remarks concerning chicks are of interest: "An abundance of good vitalized air is an important factor in poultry raising. The fresh air chick comes into the world with an especially good lease on life for he is possessed of one of the most valuable qualities in man or beast, that of power

of resistance or disease resisting ability. When we want a fire to burn more freely we open the drafts and allow a free contact of the air with the fuel; when we want the best development of the chick or better results with adult fowls, we must see to it that the supply of oxygen is unlimited. The best way to do this is to let the chick live in the fresh air from hatching time to maturity."

Joseph Tolman, Rockland, Mass., one of the pioneers in fresh-air housing, says: "In the spring of 1903, after eight years in the poultry business, using old-fashioned, closed house methods, and having very poor results, I decided, upon the advice of Dr. Prince T. Woods, the well-known writer and authority on poultry diseases, to give my fowls more fresh air both night and day. I have learned that fresh-air methods mean better, healthier, more profitable poultry. Fresh air prevents and cures disease. It increases the egg yield, insures fine fertility, good hatches, and big sturdy chicks that live and thrive. Fowls housed in my open-front house show practically no check in egg yield, no matter how severe or how sudden the winter changes of weather may be. I was nearly down and out. Adopting fresh-air methods put me on my feet again and enabled me to make a success of my poultry keeping. Now, after nine winters of fresh-air housing of breeding and laying stock and fresh-air rearing for the young flocks, I am planning to build more open-front buildings and have invented and built a large successful fresh-air brooding system that makes chick raising easy."

D. W. Rich, Mount Pleasant, Iowa, has had five or six years experience with open-front houses and finds them a great success in the severe and changeable climate of that section. Such houses are still quite new and novel in his neighborhood, but his success with them is interesting many poultry keepers. Among the benefits of fresh-air houses claimed by Mr. Rich are: "Hardier, healthier and more vigorous fowls, with roup and colds almost eliminated." He believes that in the near future the open-front house will be the type of poultry building in general use throughout the middle west.

F. C. Marshall, West Burke, Vt., prefers open-front colony houses and believes that they will solve the problem of producing and maintaining healthy poultry in his state. He finds that it has improved the health and vigor of his flocks.

Dr. C. Bricault, Lawrence, Mass., says: "I was a warm-house advocate at first, but when I saw the good effects of the open house I adopted it and I would not go back to the closed house. I have tried open-front houses over twelve years, so am in a position to judge."

Prof. James Dryden, Oregon Agricultural College, claims that tests he has made show that fowls prefer an open-front house even though they have been accustomed to a closed house. A flock which had been originally divided equally between two houses, one closed and the other open-front, was given the choice between the two houses and at roosting time about nine out of every ten of the hens crowded into the open house. He says:

“It is the nature of the hen to roost in the tree rather than in a house, and the poultryman should study her nature if he wishes to succeed.

“There are times, of course, in severe storms when chickens prefer the shelter of a roof to roosting in a tree, but the lesson is that fowls prefer the out-door life, or the ‘simple life,’ and when we put them in close houses and compel them to live there under the mistaken notion that we are being good to them we are imposing conditions that will result in decreased vitality. Housing is really an artificial condition for chickens and it is a serious mistake in poultry-keeping to follow too closely artificial lines.”

Many more successful poultry workers could be quoted in favor of the open-front house, but this chapter must be brought to a close and I will cite but one more authority and that an important one. Many poultrymen who believe in fresh-air are still afraid to use an entirely open-front house in cold climates and cling to curtain-fronts or curtains in front of the roost. With fine mesh wire netting over the open front curtains are more objectionable than useful. I do not believe in the use of curtains, no matter what kind of fowls you keep or where your house is located. Curtains, or any kind of shutters, in the front of an open-front building defeat the purpose of the house. Curtains collect dust and filth and strain the air through it. They get wet and foul and render the house more liable to dampness. I cannot see any possible practical use for curtains in an open house except that they may possibly keep out the little snow which sifts in through the wire screen, and the snow does not blow into a properly constructed fresh-air house in sufficient quantity to cause any trouble. I do not approve of curtains in open-front houses and I most earnestly urge you not to use them. Build your house right and you will find it all right when run open. Here are some extracts on the subject from the 1909 Report of the Department of Agriculture for the Province of British Columbia. When the open-front house has proved better than the curtain-front or the closed houses in a climate like British Columbia, I don't think that any of us need worry about the use of



open-front houses in severe cold climates. Following is quoted from the report:

“In place of the curtain-front houses we find the open-front houses giving better satisfaction. Considering the climatic conditions of this Province, the open-front house is deemed most advisable.

“What the curtain-front house was to the closed house, so the modern ‘fresh-air’ house is to the curtain-front house. The advantages of this house over the curtain-front house are many. It is less expensive and less labor is required in tending the flocks. A larger supply of pure air is supplied to the fowls at all times, thus keeping the birds in better health, with an increase in the fertility of the eggs and a larger egg yield.

“The birds are protected at all times from draughts by the tight back, sides and roof. Only one side of the house being open, cold winds do not penetrate the house. The fowls are more comfortable all of the time and seem to enjoy the greater abundance of fresh air than is supplied by the old closed house or when the air is diffused through a curtain.

“In brief, a cheaply built house with an open front, will give equally as good results as, if not better than, a more expensive or warmer house. Not only will poultry lay more eggs if the house is supplied with plenty of fresh air, but the hatchability of the eggs from such houses will be greater, and a stronger and more thrifty brood of chickens will be the result.”

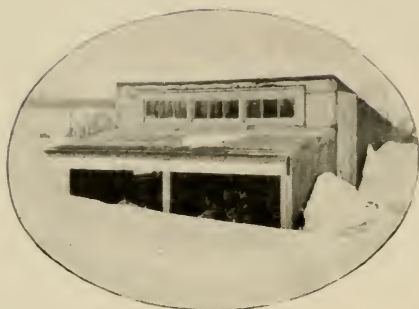

Woods' open-front house in use at Oak Hill Poultry Farm, Kingsbury, Quebec, March 11, 1911. Snow was four feet deep and photo was taken five feet above snow level. There was a five-foot drift back of door. Houses are single boarded and sides covered with "Neponset rope roofing" and roof with "Paroid." These houses are rebuilt 12x12 colony houses to make fresh-air houses 12x18 feet.



Two Woods' open-front poultry houses at Oak Hill Farm, Kingsbury, Quebec, March 11, 1911. The further house is almost hidden by snow drifts, which cover windbreaks completely.

## CHAPTER III.

### Hints and Helps on Building



EXPERIENCE in carpenter work need not be extensive in order to build an open-front poultry house. Anyone who has any aptness for learning how to handle tools can soon master the essentials of house building and will not find the work of construction very difficult.

Right here, in Plymouth County, Massachusetts, two city girls have started in the poultry business and are making a success of it. They had had no experience with poultry or in carpenter work, but they determined to build their own poultry houses and they did it and did it well. If two inexperienced city girls can frame, board in, and shingle a building and make a good job of it, others can certainly learn to do it and the man or well grown boy who thinks that he can't, ought to brace up and *try*.

The tools required are not many; a full tool kit is mighty handy to have but is not necessary. The following will serve the purpose of the amateur builder:

Spirit level with plumb.

Folding two-foot rule.

Steel square.

Chalk line and chalk.

Carpenter's pencil.

Nail hammer.

Nail set.

Shingling hatchet.

Ratchet bit brace.

One-inch bit and a bit of same diameter as window bolts.

Medium hand saw.

Rip saw.

Compass saw.

Screwdriver to fit bit brace.

Small monkey wrench.

Combination pliers.

Draw knife.

Plane.

One-half inch chisel.

Axe.

Crow bar.

Post hole digger.

Round point shovel.

While many useful tools might be added to the above list, it will make a very handy kit for the beginner. A man handy with tools, and used to working with whatever comes to hand, can get along with considerably less. I used to do my own building with a very small outfit, consisting of a good strong pocket knife, a shingling hatchet, two saws, a screwdriver, crow bar and a round pointed shovel; and I got along very well.

*Boards.* In selecting the materials for house building a considerable saving can be made on the covering boards if the outside of the house is to be covered with some good roofing felt (heavy roofing with a graveled outer surface preferred). In such case common

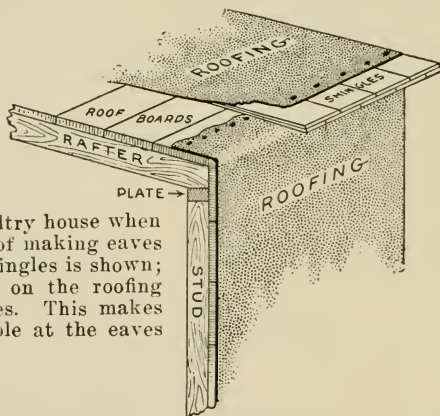

Detail of eaves of poultry house when flush boarded. Manner of making eaves with double course of shingles is shown; also method of putting on the roofing fabric on roof and sides. This makes the tightest joint possible at the eaves and is wind-proof.

“wormy” box boards to be had at from \$7 to \$9 per thousand will answer very well. They are not quite good enough or heavy enough to shingle over. Common country “bull” or pitch pine boards can be had for from \$8 to \$12 per thousand, that will hold shingles as long as the nails last, but small nails must be used that will not go through the boards. All of these boards are usually cut in box board mills and run  $\frac{5}{8}$ -inch in thickness.

Common  $\frac{7}{8}$  or 1-inch hemlock or other covering boards are best for holding shingles and cost more; usually cannot be had for less than \$24 per thousand.

North Carolina hard pine matched  $\frac{7}{8}$ -inch “roofers” cost me

\$25 per thousand and I put them on up and down without any covering and give them a good coat of paint. This makes a neat house. The roof boards are covered with roofing material. It is a little trouble to make such a house tight, but it appears to be comfortable; though, personally, I like a shingled house better. The house shown in the illustrations described in Chapter V are from photographs of Woods' house covered in the "N. C. roofers" and which were taken before house was painted. Such a house could be shingled but it would not be economy to shingle over matched boards as such lose the width of the match in laying and do not cover as well as common boards. For shingling, the house should be boarded horizontally.

*Frame Material.* For frame of building common country pine framing stuff can often be had cheaply in some sections, but it seldom pays to use it. Good spruce framing material can be had for slightly higher cost, is a great deal stronger, holds nails better and makes a much better and more lasting building. If

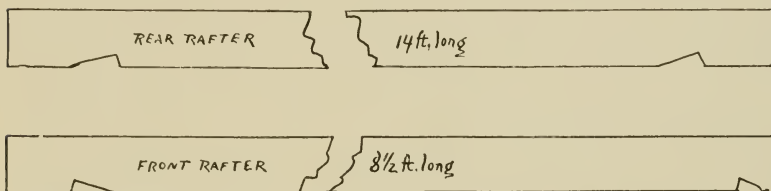

Diagram showing method of notching rafters for Woods' Open-air Poultry House.

you frame with pine you need larger timbers than where spruce is used.

*Roof and Shingles.* For covering the roof I like good clear shingles best, laid  $4\frac{1}{2}$  inches to the weather. It takes about 800 shingles to cover 100 square feet when so laid and requires about 4 pounds of shingle nails to fasten them on. A man can lay 1,500 to 2,000 shingles a day. In laying shingles always have a double course at the eaves.

Where shingles are used to cover sides they may be either first or second "clears" and may be laid either 5 or  $5\frac{1}{2}$  inches to the weather. So laid it will take from 720 to 655 shingles to cover 100 square feet. If shingles are so put on as to lap or break joints at the corners of the building it makes a good tight and attractive finish and no finishing boards are needed for the corners. If finishing boards are used, waterproof sheathing paper should be

used under the joint where shingles and finish boards meet. Finish boards or a frame will be needed around doors and windows, and it is well to rabbet the top finish board of door or window to allow shingles to lap over it and keep out the weather.

Where shingles are used paint the finish boards, doors and window sash, but do not paint the shingles; let them weather. Weathered shingles will last longer than painted ones and I think that they look better.

Make your building to use and wear, save on the cost where you can without sacrifice of strength or durability.

*Nails.* Where  $\frac{5}{8}$ -inch box board stock is used I prefer six-penny cement coated wire nails for boarding in, and three-penny galvanized cut nails or cement coated wire nails for fastening on the shingles. The galvanized nails will last longest. If boarding in stock is  $\frac{7}{8}$ - or 1-inch thick boards, use eight-penny cut nails to put on the boards and four-penny galvanized cut nails for laying the shingles.

For frame where eight-penny nails are not sufficiently large to hold when "toe-nailed in," use  $1\frac{1}{4}$ -inch or thirty-penny wire spikes. Ten-penny nails may be used in framing.

It takes from 4 to 5 pounds of nails to lay a thousand shingles. About 30 pounds of eight-penny nails are required for each thousand feet of covering boards.

*Floors.* The character of the soil on which you locate your poultry house should determine the kind of floor. Exception to this rule where for any reason it is desired to elevate the house and have a run beneath it. Where house is elevated you must have a double board floor.

On light sandy, leachy, well-drained soils an earth floor will answer every purpose and prove satisfactory, but it will not be rat-proof.

On heavy or clayey soils, or in any location that does not drain well, or where sub-soil is such that it is difficult to keep an earth floor sweet and wholesome, then use a raised board floor (that you can get a good ratter dog under), or lay a good solid cement floor laid on a bed of rock or cinders or on a layer of two-ply tarred paper.

Cement floors are best and may be made six parts good coarse sharp sand and clean gravel to one part cement (parts by measure). Mix well dry and do not wet until ready to use. Use just enough water to have it wet through and to handle well. Tamp it well in place. Make the cement floor  $2\frac{1}{2}$  to 3 inches thick inside of house and about 6 inches thick under sills for foundation.

Set wood sills in cement or bolt them to it. Floor inside should come about half way up on inside of sill. Sills should be placed before cement sets. A finish coat of one part cement and two parts sharp sand will give a better floor and may be made smooth. Make it half an inch thick and moisten the first cement floor before you lay the finish coat. A cement floor is always better for having a good crushed rock or cinder foundation under it.

Wood floors must be tight and smooth or you cannot keep them clean. There must be a way to get under them or rats will nest beneath the floor. Wood floors should be double and top layer should be laid across (at right angles to) the bottom layer. Tar paper between the layers is advisable if top is not made of matched boards.

Floors of either wood or cement should be covered with 1 or 2 inches of sand for summer use and with 1 or 2 inches of sand and 6 to 8 inches of bright straw litter (to be renewed when badly soiled) for winter use.

Earth floors need more attention than any other kind. If not cared for the soil will become contaminated to a depth of not less than 10 inches and sometimes 18 inches in a single year. If neglected, and the soil not renewed at least once and better twice a year, the soil may become contaminated with disease producing germs and filth to a depth of 3 or more feet in a few seasons. To keep an earth floor sweet, in a sandy location, requires the removal of at least 12 inches of top earth each year and renewal with new sand.

*Framing.* Spruce is the best framing material. Don't frame too light. If you board up and down you will use less framing stuff. I would not board the roof up and down; roof boards are more difficult to lay that way and cut to more waste and it does not make quite as stiff a building. Where matched stock is used and no covering, board sides up and down. You must decide on how you will board in the building before you place your frame.

For sills of building 20x20 feet, use outside sills of 4x6-inch stuff and a middle sill of 4x4-inch; 10x18 foot buildings or smaller use outside sills of 4x4-inch stuff; no middle sills required.

For studding, straps about windows and doors, and for plates use 2x3-inch stock. Place as shown in plans in Chapters V and VI.

For roosts use 2x3-inch spruce stock, with 2-inch smooth side up and sharp edges rounded with a plane.

For rafters use clear 2x4-inch spruce. Place 2 to 2½ feet

apart unless you have a middle partition which supports roof, when they may be placed 3 feet apart. Bear in mind that the roof has to be strong enough to hold the weight of snow in winter. Rafters should be notched to fit plate (see illustration), but do not notch too deep as it will weaken rafter.

Either eight or ten-penny nails may be used in fastening studs in place. The larger nails are easier to place to hold. I like to spike plates and strap to studs and to spike rafters in place. It is easier to do that way if you are working alone. When putting up the frame get all sills level and the studs plumb. Fasten them in position with brace timbers until you can nail them firmly in position. Keep the frame well braced and be sure that corners are all plumb until you have stiffened the building sufficiently by laying covering boards enough to hold all in place.

Framing is the difficult part. If you get your frame right, the boarding in is easy.

*Eaves.* Before you put up your frame decide whether you want to make projecting (or overhanging) eaves, or to make flush joints at eaves when boarding in and get your overhang with shingles.

It is easier to make the flush joint eaves tight and wind proof. To do this the rafters are cut short so that they are just flush with the outer edge of the plates. The roof boards come down flush with ends of rafters and the side boards come up flush with the top of roof board. On this joint at lower edge of roof a double course of shingles is laid to break joints and to form an overhang of 3 inches beyond side boarding, forming the eaves and carrying the drip away from the building.

To make projecting eaves the rafters are cut long to extend from 6 to 8 inches beyond the side walls front and rear. The side boards are put on up to level of top of rafters and planed to fit roof boards, which are laid to end of rafters and to cover a narrow finish board nailed to end of rafters. It is a difficult joint to make tight and is usually blocked still further by boards fitted between rafters; placed over the shingles or siding fabric and made as tight as possible.

*Side Walls.* Double walls with "dead air" spaces and all such expensive nonsense are not necessary for buildings intended for breeding and laying stock. Leave the double wall for the brooder house, which must be insulated in order to save waste of heat and coal.

A single wall is the best for the poultry house and it costs less. In climates where the winters are mild the side walls may be boarded up and down and made of matched boards or of common



boards and the cracks covered with wide battens. Such houses have yielded good results where winters are severe, but personally I like the appearance of a building with shingled sides, believe that it lasts longer and know that the side and rear walls are much more apt to be tight than where matched stock or battened common boards are used.

If boards are to be covered with roofing fabric or with shingles you can save more than the cost of the shingles or roofing by using cheaper boarding in stock.

*Foundations.* It pays to make a good foundation for a permanent building. If set on posts use cedar posts and set three feet in the ground. If you have a cement foundation get small rock and cinders for at least a foot below your concrete and have your cement or concrete wall at least 6x6 inches in which your sills are fastened to bolts fixed in the cement. If you use only a rock foundation get it low enough so that frost will not move it. See paragraph on cement floors in this chapter.

*Portable or Permanent Buildings.* Large colony buildings should be built to stay on a permanent foundation. Small colony houses can be made portable. If so built they require stiffer framing and heavier sills to stand moving about. If made to move they require no floor and sills should rest on the ground or on thin boards. Moving the house to new ground once each season will insure a clean and safe earth floor. They should only be used on well drained land. Portable houses for damp or moist locations should have board floors; or when placed in position for the season should be filled with dry sand to the level of top of sills.

In buying covering boards or framing stuff buy such lengths as will cut with the least waste. Refuse boards with large loose knots, and cracked or split frame stuff. Do not accept badly warped or twisted boards. You can only afford to use cheap lumber when you buy it at so low a price that it makes waste and shrinkage a matter of small importance. If you have to pay the going price for good material, insist on getting good material and have it in lengths that will fit into your building with the least possible waste. You have to pay for the waste.

When you buy new windows, paint them before you put them on and touch them up again afterward. It pays, and makes the windows last longer and holds the putty in place. If not painted the putty will dry and fall out after a brief exposure to the elements.

*Elevated Houses.* Some poultrymen, especially those with limited land area, like an elevated house or poultry house on stilts. The

open-front house built with a board floor can easily be built that way. One of the first Woods open-air houses was built on stilts  $2\frac{1}{2}$  feet above the ground level and was made rat proof by inverting metal pans over tops of posts before the sills were spiked to the posts. It makes a good house so built. It requires a double board floor. The space beneath the house is used as a run or shelter when the fowls are permitted to run. Such a building is best built on a slope so that soil beneath the house will wash well in heavy storms, otherwise it is difficult to clean out beneath the building. Friends in Massachusetts and in Michigan built a number of Woods houses after this plan and like them very much. See illustrations.

## CHAPTER IV.

### Location of Poultry Houses



AND for the poultry house site should be conveniently located and well drained. While fowls will thrive and do well on almost any kind of land that is not too heavy and wet, and while poor light land that is not available for cropping will serve, it does not follow that poor land is best or that it is particularly desirable and economical to use for poultry runs.

Land that will grow small fruits, orchard trees, and take a good grass sod is best and will yield the best returns. Good corn land is excellent, and a not too heavy loam that will grow garden truck can be made use of to good advantage. The advantage of such locations for profitable poultry keeping is considerable. You can alternate crops and poultry, make your land pay you a profit on both crops, and, what is equally important, cropping the land part of each season, or every other season, will keep the soil sweet and prevent diseases which result from poisoned ground.

Do not think that because sandy and gravelly soil can be used for poultry that you should seek to provide it. Sun-baked, bare runs are not desirable and are only to be considered when no other location is available. I have in mind a Springfield, Mass., poultry-keeper who several years ago called on me to tell him what was wrong with his breeding stock. He had located his poultry house, an expensive one, on a very desirable southerly slope with a fine stretch of well sodded grass land in front, where the yards were to be located. He had read somewhere, or someone had told him, that fowls do well on sand and gravel, and had conceived the notion that the fine black soil, well turfed with grass and clover, in front of his house, was not the right thing. So, he had the sod removed and then filled in the yards at least a foot deep with gravel and sand. He could not understand why his fowls failed to do well and I had some difficulty in convincing him that he had spoiled his runs to the detriment of the fowls, and that the original grass land was almost ideal as a poultry run before he tampered with it.

Low, heavy clay soil: that floods with water in heavy rains and in spring and fall, and that bakes dry and cracks in hot, dry

weather, is the least desirable of all locations for a poultry plant. Yet a certain man, well known to the poultry fraternity, selected just such a site several years ago to establish a model poultry farm for experimental and instruction purposes. There were plenty of better locations near at hand to be had for less money, but he would have that one in spite of all opposition. It has cost thousands of dollars, has an elaborate system of tile drainage that don't work very well, on account of the lay of the land and the character of the soil, and so far as I have been able to learn has not yet been able to make a creditable showing in the production

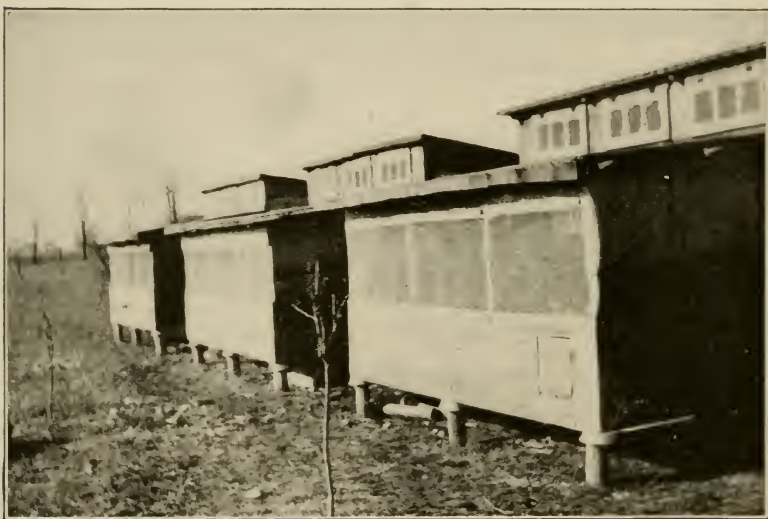

Spring Garden Poultry Farm, Frank W. Floyd, Prop., Birmingham, Mich.

of poultry or poultry produce, though it has been in operation a number of years and has had enough good money spent on it to establish several good practical plants. Today it still poses as a plant built to demonstrate to others how to go into the poultry business. Nevertheless, it is looked upon as a subject for joke and jest by such practical poultrymen as have visited it, and it certainly is a monumental example of how *not* to do it if you want to establish a practical and profitable poultry farm.

Salt marsh and moist meadow land, if fairly well drained, can be utilized for poultry provided the houses and a part of the range

are high and dry. You can use such land if you have to, and where fowls can run on high and dry land a part of the time there are lots of worse ranges than a good salt marsh.

The best location is a gentle southerly slope of light sandy loam, not too light to take a good grass sod, and having a good coarse sand or gravel sub-soil. If such a location is convenient for a water supply and is sheltered with evergreen trees on the north and west it makes a very nearly ideal place for building a poultry plant. Rolling land, with the hollows between the knolls or hills, well



Spring Garden Poultry Farm, Frank W. Floyd, Prop., Birmingham, Mich.

drained, makes a good location, but don't get the poultry houses in the hollows.

Get your poultry house in a place where water, from melting snow and from heavy fall of rain, will always drain away from the building. You want the drip from the roof to run away from the house, not under and into it.

Facing the house is a matter that will depend some on the particular location selected, its relation to the surroundings and the climate in which the house is built. Wherever there is considerable frosty or freezing weather in winter, place the house so that it will get the most sunlight inside during the cold season.

The prevailing wind storms for the particular section should

also be taken into consideration, also whatever windbreak there may be near the house. Try to locate the house, sunlight considered, so that the sweep of the prevailing winds will strike the house at an angle, rather than flat on sides or ends.

My buildings face due south and south by east. Those that face south by east get the most winter sun. Some houses to be built on the southwesterly slope will be made to face about south-southwest. The essential point is to get as much sun as possible into all parts of the house (so far as construction permits it) and to have the front take the worst southerly storms a little on the slant rather than direct.

The immediately surrounding country will have more or less influence on the position of the poultry house. The Woods house built for purpose of illustrating this book is located on a slight ridge on a southerly slope and land drops very gradually from the house to the south and a little to southwest and southeast. This building faces south 10 degrees east and is just about right for the location. One hundred yards north of the building is a strip of thick pine woods on slightly higher land. About 125 yards to the west is lower land well wooded, mostly white pine. To the south and east there is open country for a considerable distance. To the south and southwest some 300 yards or more away is the pond and the outlet of Silver Lake and through this opening come some of the fiercest winds of this location. The house gets the force of this wind directly on its southwest corner and the wind blows around and over the house, but does not make itself felt in it. Southerly storms, with heavy rain, blowing directly across the open land and striking this building almost flat on the wire screen of the open front, have not wet the floor for a greater distance than 3 feet immediately back from the opening and then only a very little water has blown in, not enough to make the floor very wet. It dries out very quickly. In November, 1911, we had three exceedingly heavy rains accompanied by very high southerly wind which drove the rain before it at an angle of about 20 degrees or less. The house staid dry and comfortable through those storms and we are not likely to ever experience anything more severe unless we get a cyclone which will carry off the building.

It is a good plan to provide wind breaks to shut off the northerly storms in winter. A good row of evergreen trees is about the best possible wind break, but stacks of marsh hay, straw, and corn stover are excellent and can be utilized so as to provide outdoor scratching places in winter. Corn stover in shoeks set in rows on east and west side of house, and extending 20 to 50 feet in front

of the building, will make a fine wind break and provide an outdoor run for winter use that is well worth while. The shocks are best placed against fencing so that they will hold up in high winds. Where a drive or walk runs in front of the house let the row of shocks extend to east and west and turn out the fowls on south side of the rows.

Wherever houses are located in exposed positions attention given to providing suitable wind breaks will be well repaid. The secret of profitable poultry keeping is making your fowls comfortable at all times. Comfort means much.

Personally I prefer a number of colony houses to a long or continuous poultry house, though there is some saving in labor with the continuous house where a large number of birds can be cared for under one roof. With colony houses conveniently arranged with a view to labor saving, and so disposed as to make best use of the land available for poultry, there is very little extra work and the danger in case of sickness, or other trouble, is very much less than where a long house is used.

Owing to the wide stretch of open front in a long house I prefer to have a solid partition for every twenty feet of length of the building.

The plans given in this book are for colony houses but can be made to suit the requirements of anyone who wishes a long house, by simply considering the plans as for one section of a continuous building, and adding as many sections as may be desired to give the length of house wanted.

The open-front house may be operated with or without yards. For breeding stock plenty of yard room is to be desired. Where fowls are kept for laying only, they may be confined in the house all of the time if not too crowded. One hundred layers may be kept the year 'round in a Woods open-front house 20x20 feet of stud specified in plans given in this book.

Long, narrow yards are to be preferred to short ones. Where possible each house should have two yards, or double yards, so that one can be cultivated while the other is in use for the fowls. With a long, narrow yard you will need rather less space per bird than where square yards are used. Allow from 50 to 75 square feet of yard space per bird.

Using open-front colony houses each 20x20 feet, 1,000 breeding birds can be comfortably housed and provided with double yards on about three acres of land. If there is plenty of land available from four to five acres per thousand head of breeders can be used to better advantage. If continuous plan house is used 1,000 breeders

can be housed and yarded on from two and one-half to four acres, according to the lay of the land and the shape of the lot. For layers smaller yards may be used or the birds may be confined to the houses and not allowed to run out. Some successful egg producers use the latter method, keep the layers confined to the house, push them hard for egg production, market the flocks when egg yield falls off in summer, just before moulting time, and then stock the houses up again with new flocks of pullets and young hens.



## CHAPTER V.

### Dr. P. T. Woods' Improved Open-Air Poultry House



IN THE FALL of 1908 an experimental Woods' open-air poultry house was built on an exposed hillside on a farm in northern Massachusetts. It yielded such satisfactory results that the plans were published the following summer. The house became immediately popular and many were built by poultry keepers throughout the United States and Canada. Reports from north, south, east and west show that the house has proved satisfactory under a very wide range of climatic conditions. It has stood the test of severe winters with heavy snows or with high winds and bare ground, and of hot, dry summers and wet, cold and foggy seasons.

The house has been built of various dimensions and used as a laying house, a breeding house and as a house for the operation of individual brooders. Reports received thus far have been very gratifying. One poultryman reports that he intends to build a hot-water pipe brooder house on a modification of this plan, using curtains between front and rear section and for the open front to prevent waste of coal and heat and to aid in regulation. The 20x20 foot plan has been built as a colony house and as one section of a long or continuous house. In 1910 a Woods' open-air house 20x400 feet was built on a Connecticut farm and proved so satisfactory that another house of same size was built in 1911. In the same season two of these houses, each over 400 feet long, were built on another Connecticut poultry farm. A Michigan breeder built one to house 500 breeders and has found it very satisfactory. Personally, I prefer the colony house.

If the house is to be built on the long or continuous plan, the 20x20 foot plan is best and I would not build a long house that has sections smaller than 10x16 feet. Would keep these houses the same height as the 20x20 foot house herein illustrated.

For small colony houses the best dimensions have proved to be 8 feet wide by 14 feet deep for flocks of from 5 to 25 birds. This house can be made a little lower stud than the 20x20 house and three light "cellar" windows used in the monitor-top, if desired. For flocks of 30 to 40 birds the house can be made 10x16 feet or

10x18 feet for flocks of 40 to 60. I prefer such houses built the same stud as the 20x20 foot house and to use six-light sash in the monitor top. The large colony house 20x20 feet will give comfortable quarters for 100 layers or breeders and 150 layers can be housed in it. There is nothing to be gained by crowding the house to the limit of its capacity. One hundred females and 5 or 6 males are enough to keep in the house for best results, but in the fall and early winter when there is surplus stock on hand and house room is scarce, you can crowd them a little without doing any serious



DR. P. T. WOODS' IMPROVED OPEN-AIR POULTRY HOUSE.

Fig. 1.—This illustration shows four outer sills (4x6 in. spruce, 20 ft. long), and middle sill (4x4 in. spruce) leveled and spiked to posts. Posts are cedar and are set 3 ft. deep in ground. View is from north and west. West posts come higher above ground as house was built without grading the natural slope of the ridge. Ends of sills were halved to match in a tight rabbit joint. (Photo by Dr. Woods.)

harm, particularly if the birds have liberal range. Windows in monitor top remain closed in winter and are kept open in summer.

Woods' Improved Open-Air House, as illustrated in this chapter, Fig. 1 to Fig. 12 inclusive, was built by the author for the purpose of illustrating this book. I could not get a carpenter to build it the way I wanted it built or to wait during construction for time for

taking suitable photographs; so I had to do the carpenter work and photographing. It is, therefore, the work of an amateur carpenter and not of a skilled artisan. Owing to the considerable amount of editorial and other work that had to be done, there was little time for the house building and it had to be built in odd hours and spare time from other work.

Eventually this house will have a cement floor, but it was decided to run it through the first winter with an earth floor. No attempt was made to level or grade the land. With a square and line the

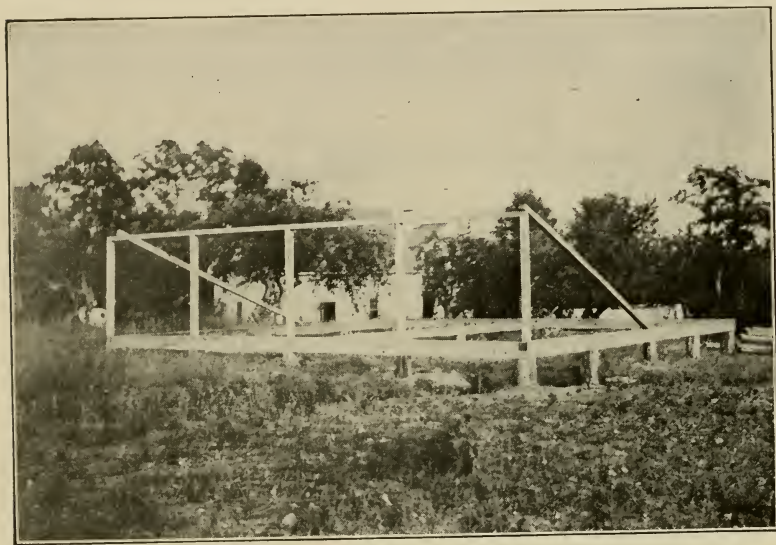

DR. P. T. WOODS' IMPROVED OPEN-AIR POULTRY HOUSE.

Fig. 2.—Dimensions of this house are 20x20 ft. sill measurement. This illustration shows the rear studs in position on sills and the rear plate made fast to top of studs. Diagonal straps are simply braces to steady the frame. Studs are made plumb and then held so by the braces. Studs and plate are 2x3 in. spruce. Rear studs are 4 ft. long and there are five of them. (Photo by Dr. Woods.)

location of the 20 foundation posts was determined and the holes dug with a post-hole digger. These posts were set 3 feet in the ground and tops were sawed to bring the sills level, with corner of sills at highest point of ground not over an inch above ground level. The ends of the sills were squared and then half sawed to make a tight rabbit joint where sills join. When sills were placed in posi-

tion on posts they were leveled and corners squared before spiking them to the posts. Middle sill was not mortised into front and rear sill, as foundation post projected enough to support it when butted to them. Fig. 1 shows posts and sills in position for foundation of frame. If a cement foundation had been prepared and bolts set in the cement to hold sills, considerably lighter sills could have been used. Sills were 4x6-inch spruce, 20 feet long and middle sill 4x4-inch stuff.

The view in Fig. 2 is taken from the same position and shows the

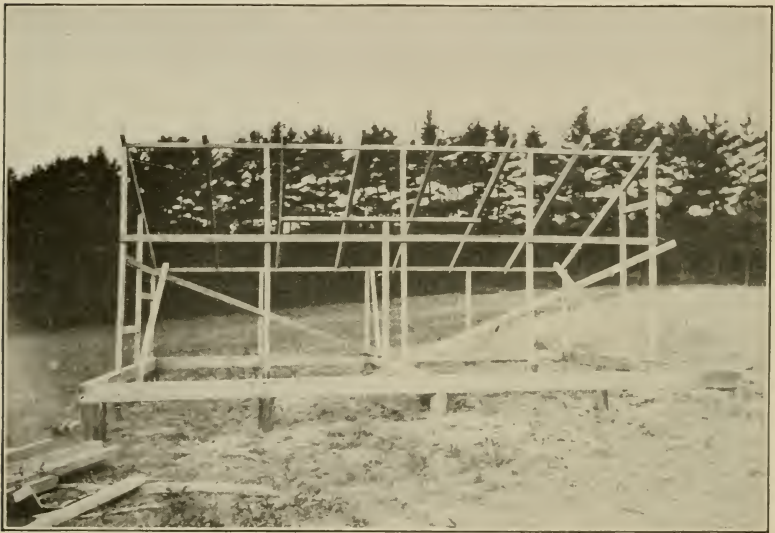

**DR. P. T. WOODS' IMPROVED OPEN-AIR POULTRY HOUSE.**

Fig. 3.—Illustration shows frame for rear or high section of the building. Middle studs (2x3 in. stock, 8 ft. long) are shown in position. Upper middle plate spiked to top of studs and lower middle plate spiked to front of studs are shown in place. Plates are 2x3 in. stock 20 ft. long. Lower middle plate supports rear end of front rafters. Stud of 2x3 in. stock 6 ft. long with "T" plate 9 ft. 8 in. long is shown in center of this section to support center of roof and to nail middle partition to. Eight rear rafters (2x4 in. stock 14 ft. long) are shown in place. Diagonal straps are for braces only. (Photo by Dr. Woods.)

next stage in construction. Here the rear studs are shown in position with rear plate in place on top of them. The diagonal straps are simply braces to held the frame during construction. This building is somewhat lighter framed than the one illustrated in

Chapter VI, as the sides here are to be boarded up and down. Rear studs are of 2x3-inch stock and are 4 feet long. There are five of them. Plate is 2x3-inch spruce 20 feet long.

The next step was to prepare five 2x3-inch middle studs 8 feet long. On top of these was spiked a plate of same dimension stuff 20 feet long, and to the front of each about 4 feet 6 inches from bottom the plate which supports rear of front rafters was spiked. This can be done with frame on ground and when it is firmly put together it is easy to raise it into position, plumb it, brace with diagonal straps and then nail to the sills and the middle posts

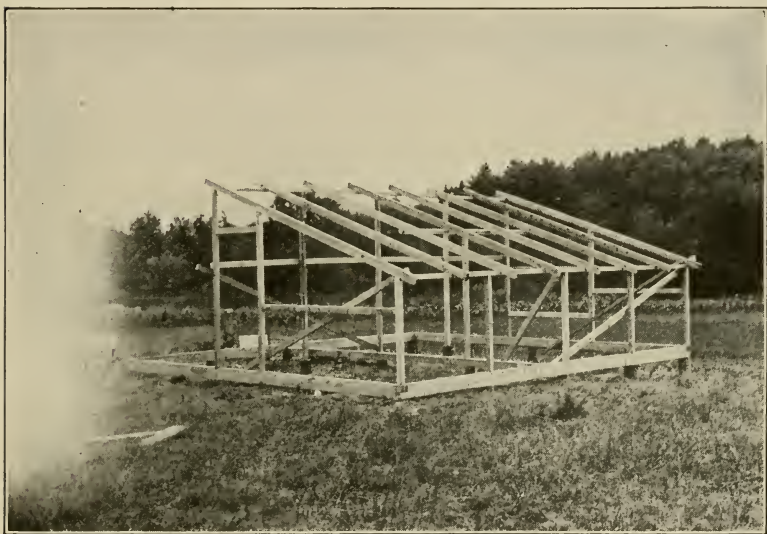

**DR. P. T. WOODS' IMPROVED OPEN-AIR POULTRY HOUSE.**

Fig. 4.—Rear view of frame for rear section shown in Fig. 3, looking from north and east. Position of studs, plates, rafters and side straps is clearly shown. This rear section is 12x20 ft. ground plan. Manner of notching rafters and placing same for overhanging eaves is clearly shown. (Photo by Dr. Woods.)

(see position on Fig. 3). Eight rafters of 2x4-inch spruce 14 feet long were then prepared by notching them to fit plates. Do not notch them too deep, as it weakens them. See illustration, Chapter III. Rafters are placed 2 feet 8 inches apart, and are spiked to plates. Fig. 3 shows frame for rear section of building, with studs, plates, side straps and rafters in position. Stud on

east side is 2x3-inch stock 7 feet long and is placed 3 feet from middle stud; 3 foot strap is placed between studs at 6 feet from sill and forms top of door frame. Strap 8 feet 3 inches long is placed between door and rear stud to nail to in boarding east side. West side has stud 6 feet long 5 feet 8 inches from middle stud, with two straps for top and bottom of window frame 5 feet 8 inches long between it and middle stud and one strap 5 feet 7 inches long between it and rear stud. All straps are 2x3-inch

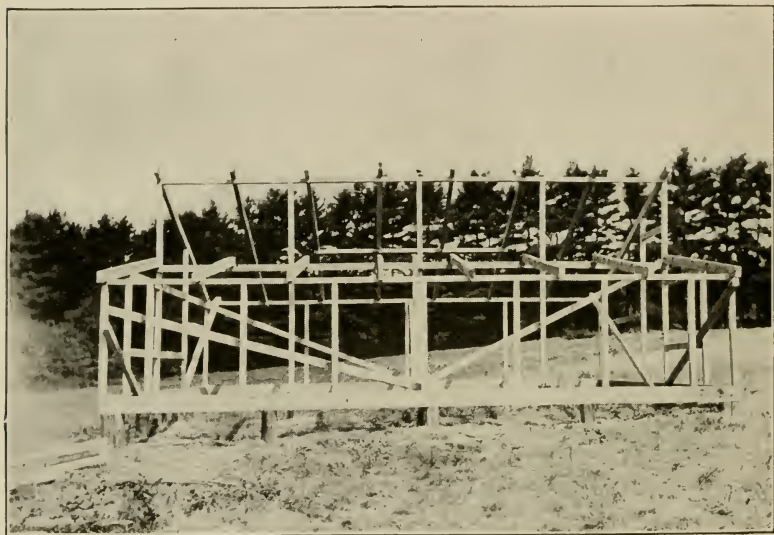

DR. P. T. WOODS' IMPROVED OPEN-AIR POULTRY HOUSE.

Fig. 5.—Front view of frame before boarding in. Frame is complete except for straps below windows for monitor top. Nine front studs (2x3 in. stock 3 ft. 4½ in. long) are shown in position; also front plate (2x3 in. stock 20 ft. long) and eight front rafters (2x4 in. stock 8 ft. 6 in. long), are shown in position. Diagonal braces are left in place until boarding in stiffens the building. (Photo by Dr. Woods.)

spruce. Fig. 4 shows rear view of framing here described viewed from northeast.

Front frame was built next. First nine studs each 2x3-inch spruce 3 feet 4½ inches long were placed in position, as shown in Fig. 5, and front plate was spiked to top of each. Eight rafters were then prepared of 2x4-inch spruce 8½ feet long and notched to fit plates and spiked in place. A "T" plate of 2x3-inch stuff

was placed in middle of rear section to give additional support to roof and to give a stud for middle partition; see Fig 3.

East and west sides of front section each have one 4-foot stud and two window straps about 4 feet 7 inches long; see Fig. 6. Straps for monitor top windows are about 4 feet 10 inches long and are placed between middle studs, as shown above front roof in Fig. 9.

Fig. 6 shows frame of east side ready to board in.

Fig. 7 shows west side of same stage of frame.

Fig. 8 is view after beginning to board in. Rear wall is put on

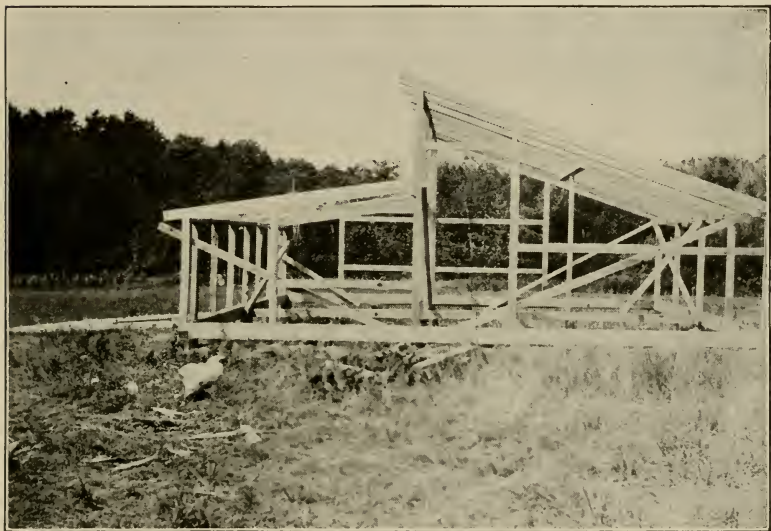

DR. P. T. WOODS' IMPROVED OPEN-AIR POULTRY HOUSE.

Fig. 6.—View of east side of frame when ready to board in. Center support for roof and stud for partition are clearly shown. (Photo by Dr. Woods.)

up and down. Partial partition in middle is boarded horizontally. This partition extends only 9 feet front from rear wall.

Fig. 9 is view of south front when nearly boarded in. The front roof is complete and covered with Amatite roofing. Window straps in the monitor top are shown in position.

Fig. 10 is view of east and north ends before putting on roofing; location of door and window is shown by openings.

Fig. 11 shows south front and west side finished and ready for painting. It will be noted that the windows are bolted on to outside of building, eight tire bolts with steel washers are used for each window, nuts are inside of house. One-quarter-inch mesh wire netting covers the open front for a space of 3 feet high by width of house. This space is always open. There is no partition of any kind between the front and rear sections of house and no curtains of any kind are used.

Fig. 12 shows south front and east side of completed building,

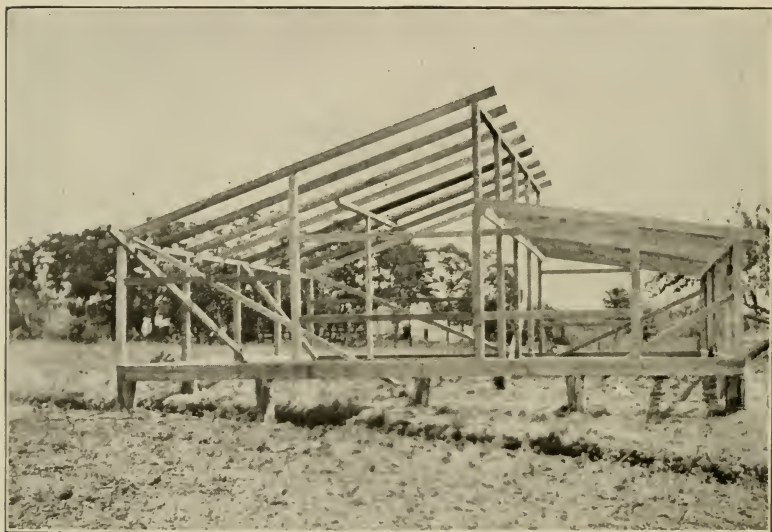

DR. P. T. WOODS' IMPROVED OPEN-AIR POULTRY HOUSE.  
Fig. 7.—View of west side of frame when ready to board in. (Photo by Dr. Woods.)

ready for painting. The door was painted to make it show up well and to prevent warping. Door has two 10-inch corrugated "T" hinges and a hinged hasp, staple and a padlock.

No droppings boards were used in this building. Floor was filled in with sand to level of bottom of sills. Roosts were placed rear of the house 2 feet above the top of sills, four on each side of the three-quarters middle partition of rear of house. Nests made of covering board stock were hung on walls of house in front of roosts. These were made 14x14x12, with sloping roof and an alighting



shelf. Bottom part of south front is boarded up to edge of wire netting. At each end of front a poultry hole (to be covered with a slide) will be cut and a cleated incline furnished for fowls to walk up on. House as shown can be built for \$100 and given a good coat of paint.

*Materials Required.*

*Spruce.*

4 sills 4x6 inches, 20 feet long.

1 sill 4x4 inches, 20 feet long.

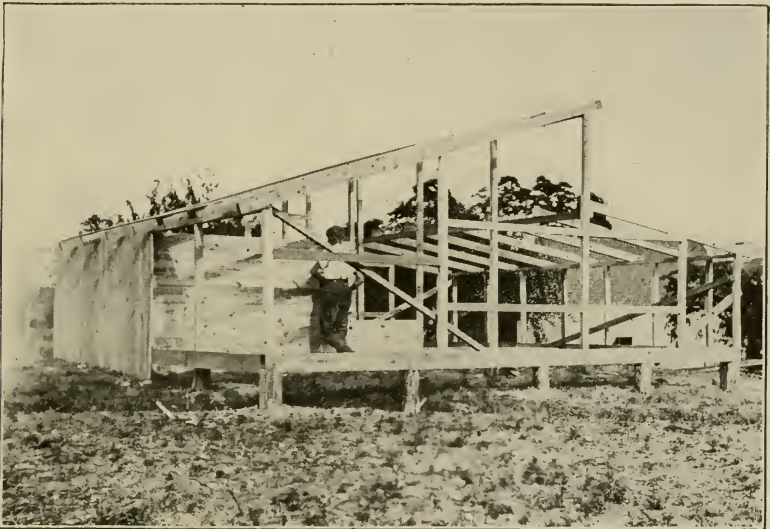

DR. P. T. WOODS' IMPROVED OPEN-AIR POULTRY HOUSE.

Fig. 8.—Beginning to board in. North Carolina hard pine “roofers,”  $\frac{7}{8}$ -in. matched stock, put on up and down for outside, were used for boarding in. About 1,300 sq. ft. of 16 ft. boards were used. Illustration shows about half of rear wall in place and boy at work on the middle partition, which divides rear section for about 9 ft. from rear wall. View shows west side and north end of building. (Photo by Dr. Woods.)

4 plates 2x3 inches, 20 feet long.

8 rafters 2x4 inches, 14 feet long.

8 rafters 2x4 inches, 8½ feet long.

8 roosts 2x3 inches, 10 feet long.

6 pieces 2x3 inches, 15 feet long to cut for studs.

3 pieces 2x3 inches, 16 feet long to cut for studs.

6 pieces 2x3 inches, 12 feet long to cut for studs and straps.

*Cedar.*

10 cedar 6-inch posts, 8 feet long to cut for foundation

*Boards.*

1,300 square feet hard pine matched roofers.

200 running feet 4-inch pine finish boards.

*Windows.*

7 six-light 8x12-inch pane half sash.

56 tire bolts  $\frac{5}{8}$ -inch,  $2\frac{1}{2}$ -inches long to fasten on sash.

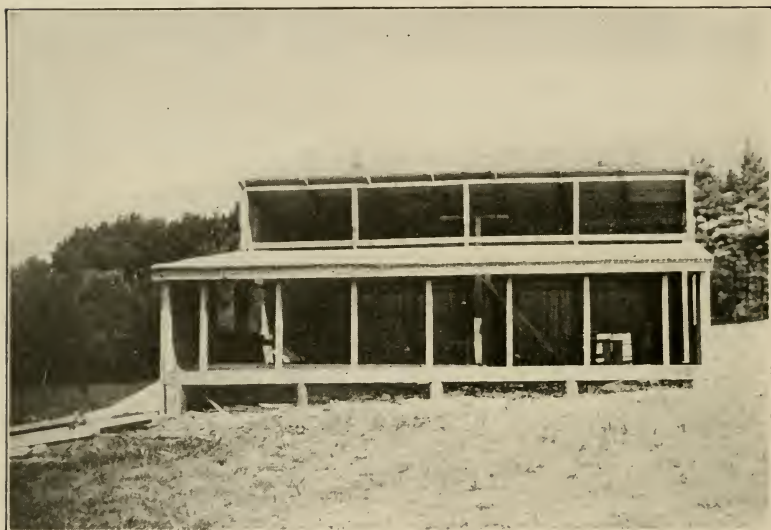

DR. P. T. WOODS' IMPROVED OPEN-AIR POULTRY HOUSE.

Fig. 9.—View of south front of building when nearly boarded in. Rear roof is not finished. Front roof is complete and covered with Amatite roofing. Straps of 2x3 in. stuff which go below monitor-top windows are shown in place. Height of monitor-top above front roof is 3 ft. 2 in. (Photo by Dr. Woods.)

56 steel washers for same to fit under nut.

*Wire Front.*

20 running feet  $\frac{1}{4}$ -inch square mesh galvanized wire netting 36 inches wide.

2 pounds galvanized wire staples for same.

*Hardware.*

30 pounds 8d cut nails; 10 pounds 10d cut nails; 10 pounds

30d spikes; 1 pair 10-inch corrugated iron "T" hinges and screws for same; 1 box 1½-inch screws for cleats on doors; hasp, staple and padlock; two gallons of ready mixed "outside" paint, any good covering color.

In the following chapter are given plans for this house when built of common boards put on horizontally and intended to be covered by shingles or some good roofing. Detail of partition is shown in Fig. 19, Chapter VI.

Here are a few more comments on the Woods' open-air house:

H. Ringhouse, Clackamas, Ore., says: "Dr. P. T. Woods' fresh-



DR. P. T. WOODS' IMPROVED OPEN-AIR POULTRY HOUSE.  
Fig. 10.—View of east and north end before putting on roofing. Opening shown for door and window. (Photo by Dr. Woods.)

air house is by far the best plan I have ever seen for the middle and eastern states, where they have cold winters, and very hot nights in summer, and it is equally good for this coast. The roosts are in the rear, where the fowls are well back from the open front, and during the hot weather the ventilation through the open windows" (in the monitor top) "makes the roosting section quite comfortable. The windows in top, together with the large window opposite the door, furnish plenty of light and allow the sun to

shine in rear part of house. I can think of nothing which would add to the value, comfort and convenience of this, the very latest and best plan yet offered. It would serve admirably as a continuous house. \* \* \* These houses are no experiment. They have been thoroughly tested alongside of curtain-front and closed houses by a large number of our leading breeders and most of the agricultural experiment stations and have proved their worth by the egg yield, better fertility and general health of the flocks."



DR. P. T. WOODS' IMPROVED OPEN-AIR POULTRY HOUSE.

Fig. 11.—Front view of completed house, showing south front and west side ready for painting. Holes are to be cut in boarded part of each side of front end for poultry doors. Wire front is shown in place. Owing to rapid development of the White Rock chicks it was necessary to move them into this house before it was finished. (Photo by Dr. Woods.)

Sidney S. Morris, Berwyn, Pa., says: "I consider a house of this type perfect and shall never build any other kind."

Frank W. Floyd, Birmingham, Mich., built a number of Woods' houses, set them up on posts, made rat proof with inverted metal pans on top of posts, provided double board floors for houses and likes this style of building very much. He has also built a long house of same type.

Ralph E. Woods, Shelton, Neb., built small colony house of this type and reported very satisfactory results.

George Gelly, Nokomis, Ill., reported for a 10x16-foot Woods house, winter of 1909, fowls went through severe blizzard in excellent condition. He says: "In it I housed 17 White Plymouth Rocks through the winter without a frozen comb or a cold of



DR. P. T. WOODS' IMPROVED OPEN-AIR POULTRY HOUSE.

Fig. 12.—View showing east side and south front before painting. Door only is painted. Owing to press of other work this house did not get painted in time to show a picture of it in this book. (Photo by Dr. Woods.)

any kind. The pullets were late hatched, but they started laying in December and kept it up right through the cold weather. The house is in a very exposed position, but that does not seem to handicap it—any, so we have decided that it is about the correct thing in poultry houses."

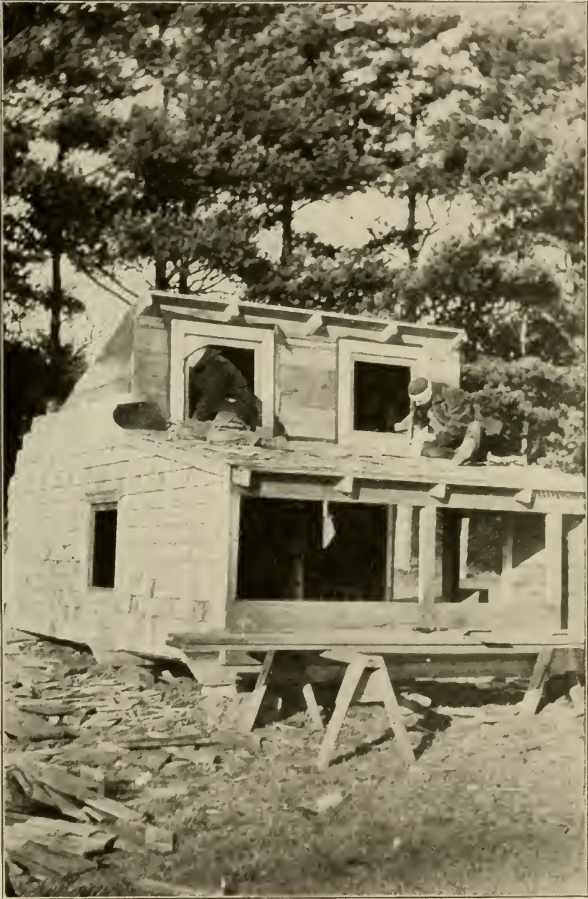

Building a Woods' house, 10x16 ft., portable colony type. Wozelma Farms Producing Co., Silver Lake, Mass. (Photo by John E. Zeller.)

## CHAPTER VI.

### Another Plan for Dr. Woods' House



THE ARTICLE and plans in this chapter are from the June, 1911, *American Poultry Journal*. This is the same house as described and illustrated in Chapter V except that it is planned and framed for horizontal boarding and the use of cheap building material to be covered with either roofing fabric or shingles. U. R. Fishel gave this house his endorsement in his catalogue for 1911 and published the plans and article in it. Here they are:

In the few years that it has been before the public the Woods' Open-Front Poultry House has made many friends. It has been successfully used in bleak and cold sections of Canada and our own northern states and has given equally good results in the warmer climate south of Mason and Dixon's line. It has been built in many sizes, both as a colony house and as a long or "continuous" poultry building. We do not claim that it is better than the several other good types of "fresh-air" houses. It is a good, practical poultry house and one that is adaptable to a wide range of locations and climatic conditions.

Open-front poultry houses have won their popularity on sound, practical merit and have come to stay. Poultry keepers who have once used a good open-front or "fresh-air" house and given it a fair trial, would not return to the old-fashioned closed building for their flocks. Even the large combed Minorcas and Leghorns have been found to do better in an open-front house than in a closed one. The size or style of the house does not matter so much provided the front is kept always open and the pens are deep enough to have the roosts well back from the opening.

Some of the advantages claimed for the open-front house are:

The front being always open there is no ventilation to worry about.

Pure fresh breathing air for the fowls both day and night.

Freedom from frost and dampness. Not an uncomfortable cold house, because air is dry and pure.

None of the penetrating chill common to closed houses in cold weather.

Comfortable at all times and all seasons in all locations.

No breathing over and over again of bad, foul, dead air.

Cool in summer and warmer and more comfortable than a closed house in winter.

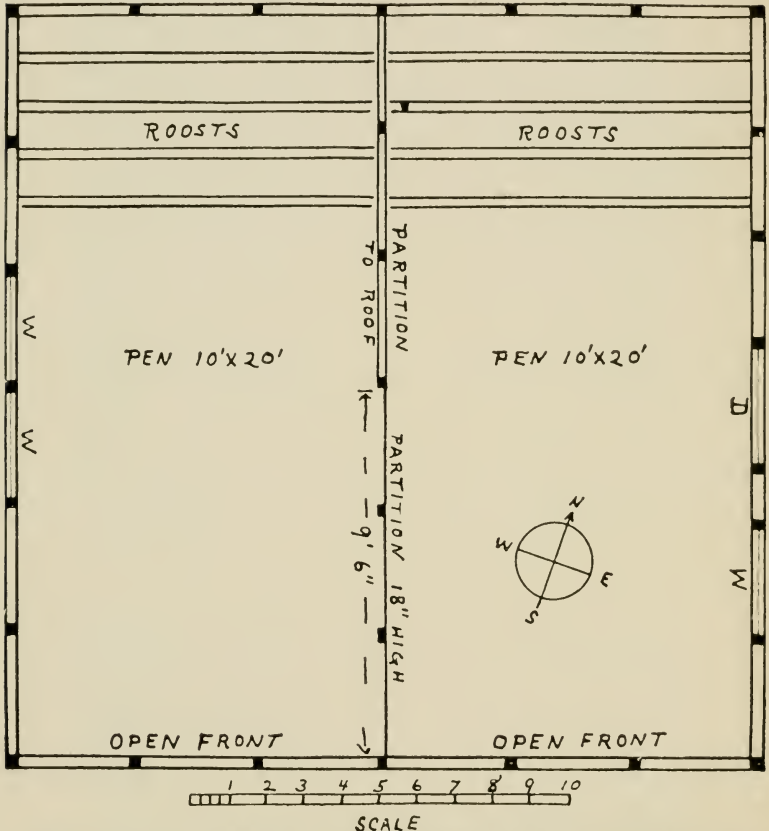

Fig. 13.—Dr. P. T. Woods' improved open-front poultry house. Ground plan drawn to scale. A strip of paper marked to correspond with scale and used on plan will give dimensions in feet. W, W are windows. D is door. Black squares show position of studs on sills.

Better health for the flocks at all times.

Better egg yield, with less tendency to be affected by weather changes.



Better fertility and better chicks from the eggs.

Better returns for the food and care given the flock.

Economical to build, easy to use and in every way practical and satisfactory.

The Woods' improved open-front poultry house differs considerably from the plans first published and is a much larger house. In essentials it is similar to the first semi-monitor-top open-air house. Features that experience has proved to be non-essentials have been eliminated. The plans here given are for a colony house for a large flock on a practical plant. By keeping the proportions similar the house can be built as a smaller colony building or as a continuous house. It has been successfully used as a long house

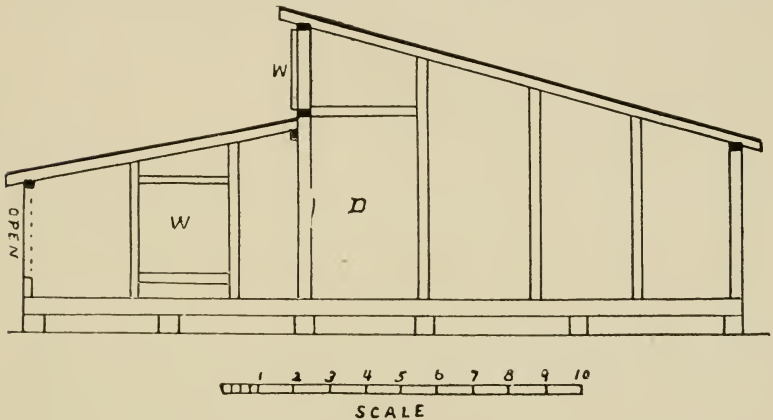

Fig. 14.—Dr. P. T. Woods' improved open-front poultry house. East elevation plan of timbers showing posts, sills, plates and rafters. Black squares are plates. W is window. D is door. Use scale on this plan for Fig. 15 also.

20x400 feet, with pens 20x20 feet: as a small colony house 8x12 feet, 8x14 feet and 10x16 feet. The depth of modifications of this house plan should not be made less than 12 feet for best results.

The large colony house, for which plans are presented herewith, is 20 feet wide by 20 feet deep, 4½ feet high in front of low front section and 6 feet high at rear of same; this front section is 8 feet deep; rear section is 12 feet deep and 9 feet high in front and 5½ feet high in rear. This gives a building with plenty of head

room where needed. Measurements are from ground level. The house will accommodate 150 layers or breeders and they will divide up O. K. on the roosts.

Fig. 13 shows ground plan. It will be noted by compass that the house faces a little east of south. This will prove best in most locations. The black squares on ground plan show position of the studs. It will be noted that the house is partly divided by a partition from front to back. This partition is solid matched boards from floor to roof from the back wall to within 9 feet 6 inches of the inner edge of front sill. This divides roosting section of house and affords better protection for the roosting fowls in very windy weather. This solid partition has not been found necessary in small houses, but with an open front 20 feet wide it proved effective in stopping strong air currents about the roosts when

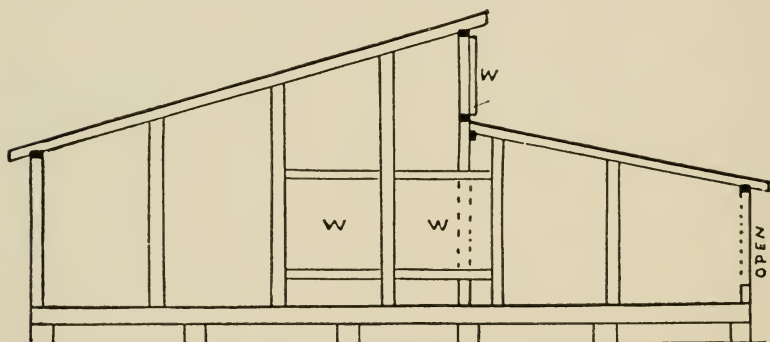

Fig. 15.—Dr. P. T. Woods' improved open-air poultry house. West elevation plan of timbers showing posts, sills and rafters. Black squares are plates, W, W are windows. Scale on Fig. 14.

both windows and doors were open as well as the front. The balance of the partition is only 18 inches high and serves to prevent interference of males. No wire is used above this low partition, the fowls having access to the whole house. Four roosts, each 10 feet long, are used on each side of full partition at rear of house. These are placed  $2\frac{1}{2}$  feet above the floor and 14 inches apart, center to center. Two by 3-inch stuff, with edges slightly rounded and placed 2-inch side up, is used for roosts. No dropping boards are used.

Fig. 14 shows east side elevation plan of posts and timbers. Fig. 15 shows west side elevation of same. Sills rest on posts 6 inches

above ground level. Posts are set 3 feet in ground. If desired the sills may be set on a concrete or stone foundation. Black squares in these elevation plans are the plates. Plans show position of sills, studding, plates, rafters, door (D) and windows (W, W). A strip of paper marked to correspond with the scale will give dimensions in feet.

Fig 16 shows elevation diagram of complete building. Note that six-light half-sash are used for windows. The open front is covered only with  $\frac{1}{4}$ -inch square mesh galvanized steel wire netting. If a continuous house is to be built the colony house serves as plan for one pen; solid partitions every 20 feet. Wire front in continuous house should be on frame and removable to facilitate

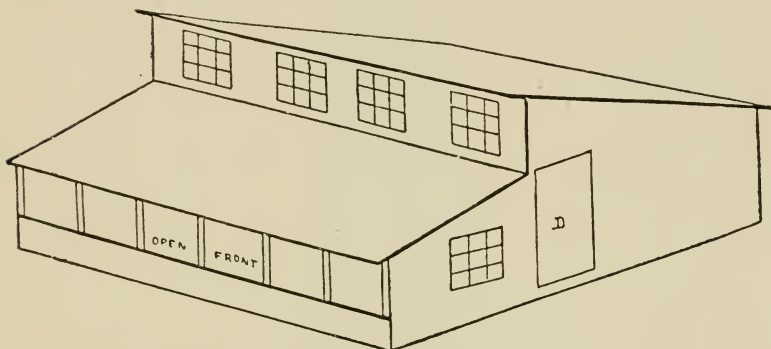

Fig. 16.—Elevation diagram of completed building—Dr. P. T. Woods' open-front poultry house. Front is always open, closed in only by galvanized wire netting, one-fourth inch square mesh. No curtains used in any part of house. Windows kept closed in winter and all wide open in summer.

cleaning house. No curtains are used in any part of house.

#### *Material Required.*

20 short posts.

4 pieces 4x6, 20 feet long, for sills.

1 piece 4x4, 20 feet long, for middle sill.

5 pieces 2x3, 20 feet long, for plates.

14 pieces 2x3, 2 $\frac{1}{2}$  feet long, for window frame.

1 piece 2x3, 3 feet long, for door frame.

7 pieces 2x3, 3 feet long, for front studs.

7 pieces 2x3, 4 feet long, for rear studs.

10 pieces 2x3, 7 $\frac{1}{2}$  feet long, for studs.

2 pieces 2x3, 5 feet long, for studs.

Library  
ANIMAL INDUSTRY  
Department



View of F. M. Peasley's fresh-air poultry house, Cheshire, Conn. An open-front house built to accommodate 2,000 layers. Adapted from plans of semi-monitor-top open-front poultry house designed by Dr. P. T. Woods. This mammoth house has "proved entirely satisfactory."

- 3 pieces 2x3, 6 feet long, for studs.
- 3 pieces, 2x3, 7 feet long, for studs.
- 3 pieces 2x3, 4½ feet long, for studs.
- 2 pieces 2x3, 4 feet long, for studs.
- 8 pieces 2x3, 8½ feet long, for rafters.
- 8 pieces 2x3, 10 feet long, for roosts.
- 8 pieces 2x4, 14 feet long, for rear rafters.
- 1,100 square feet lumber for sides, roof and partition.
- 7 six-light, half-sash for windows.
- 20 running feet of ¼-inch square mesh netting, 30 inches wide.
- 1,000 square feet roofing fabric for sides and roof.
- Nails, hinges, screws, etc.

Windows in semi-monitor top should be put on with hinges at top from outside and made to open outward. They are run wide open or taken off altogether in summer. It is a good plan to provide an inner wire netting door for use when house door is left open.

This house may be built with a double wood floor, a cement floor or with a floor of earth or sand. If earth or sand is used, fill in to level of top of sills. If cement floor is used bring it to bottom of sills and fill to top of sills with clean sand. Beach sand is excellent.



Building a portable colony type Woods' open-air poultry house, 10x16 ft., Wozelma Farms Producing Company, Silver Lake, Mass.

## CHAPTER VII.

### The Gillette Open-Air Poultry House



ANOTHER MODERN poultry house which has become popular is the Gillette Open-air House, designed and built by George K. Gillette, manager of Sugar Brook Farm Company, Central Village, Conn. Poultry houses of this type are used on the 400-acre plant of the company for housing all breeding and laying stock.

Plans for this house were first published in *American Poultry Journal* for March, 1911. In the fall of 1911, Connecticut Agricultural College and Experiment Station built a model poultry plant of fifty 12x12 feet Gillette open-air houses for the purpose of housing the North American International Egg Laying Competition, each house being divided into two pens, five birds in a pen.

Sugar Brook Farm has found this house so satisfactory in operation and so attractive in appearance, as well as economical of construction, that all new breeding and laying houses are to be built after this pattern, either as separate colony houses or as a long or continuous house, using plans for colony building as one section of the long house.

The Gillette open-air house is 20x20 feet ground measurement, 6-foot high walls back and front and 9 feet high at the peak. (See plans.) As is shown in "Fig. 17, Side Elevation," the roof projects about 1 foot beyond the front and back walls, making eaves which carry the drip from rain or snow well out from the building. There is a ventilating door for summer use in each side wall near apex. This door is 2 feet square (see "a" in plan), and in hot weather both east and west doors are kept open, making the building cool and comfortable. There is also a window ("b") in each side wall about 4 feet from the floor, made of two half sash, each containing six 8x12-inch lights. These sash are hinged at the top.

"Fig. 18, Front Elevation." shows open-front (covered only with wire netting), location of doors, poultry slides, etc.; "c, c'" are the poultry slides, each 1 foot wide by 18 inches high, located at each front corner for convenience. In some of the houses these

slides are in east and west ends near the front. The open-front is  $3\frac{1}{2} \times 9$  feet and is never wholly closed. Balance of front, except doors, is boarded. There is a door  $2\frac{1}{2}$  feet wide on either side of open front. Each has a solid matched board door which opens in, and another door (top half wire netting and bottom half cotton cloth) which swings out. The solid door is kept open all day in winter, except in extremely cold storms. In summer the solid door is kept open all the time. The screen door of wire and cloth is used when solid door is open and it is desired to confine the

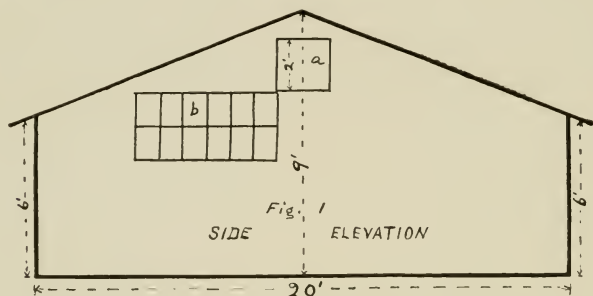

Fig. 17. Side elevation Gillette open-air poultry house; "a" is 2 feet square, ventilating door for warm weather use; "b" is glass window, two half sash each, six 8x12-inch lights.

fowls to the house, or in very windy weather when it is not considered desirable to have front so wide open. "d, d" are removable boards that are used to keep litter and sand out of the doorway. It will be noted, in illustrations of this house from photographs, that a cloth screen is shown which slides up over open front, partly closing it. This cloth screen slides in a groove of wooden cleats and is held in place by a wooden pin. Detail of curtain slide is shown in "curtain detail" in plan. It will be noted that curtain does not fit close against front of building, but is some 2 inches from it, leaving an air space between curtain and front of house. It has been used but seldom in extremely hard winter wind storms and has never been wholly closed. I am of the opinion that the curtain or cloth screen is not necessary to successful use of this house. It will be seen from the plan that roof projects about 1 foot beyond side walls of building, which is considered a desirable feature.

"Fig. 19, Ground Plan," shows the square floor plan of house



and location of drop boards and roosts. There are four roosts about 8 inches above the drop boards on each side of middle partition. Drop boards are about  $2\frac{1}{2}$  feet above the floor. As shown in the plan, there is a solid matched board partition in the middle of each pen extending from floor to roof and from rear wall to within 6 feet of the open front of the building. This partition helps prevent interference of male birds and also prevents all drafts about the roosts even when the house is run wide open in very windy weather. The flocks divide up nicely at night and do not show any tendency to crowd on one side. The 6 feet in front of the partition is always open. Houses are set on a stone and concrete foundation. Sand on floors to level of sills is preferred to straw litter. Mr. Gillette furnished the following bill of lum-

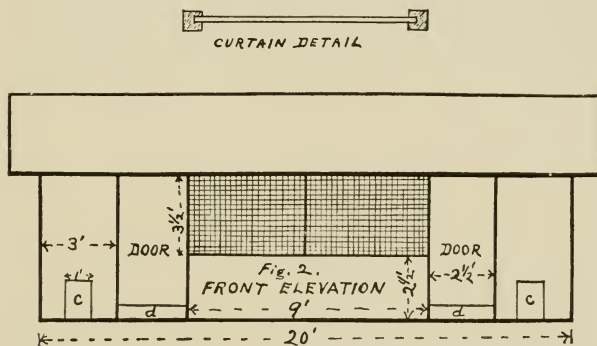

Fig. 18. Front elevation and curtain detail Gillette open-air poultry house. Wire front,  $3\frac{1}{2} \times 9$  feet, always open; "c, c" poultry slides; "d, d" movable boards to keep litter or sand out of doorway.

ber for this house and stated that the house complete, including all hired labor and stone and concrete foundation, can be built for \$100.

#### Material Required for Gillette House.

2 pieces 4x4, 12 feet long, for corner posts.

5 pieces 2x4, 20 feet long, for plates and one collar beam for center.

4 pieces 4x6, 20 feet long, for sills.

4 pieces 2x3, 20 feet long, for roosts.

4 pieces 2x3, 20 feet long, for girds.

7 pieces 2x4, 12 feet long, for studs.

22 pieces 2x4, 12 feet long, for rafters.

800 feet good dry cypress lumber, matched.

600 feet matched lumber for roof.

The sides of this house are boarded up and down and are painted. No paper or shingles are used on sides. Roof is covered with roofing fabric.

"Fig. 20," is from a photo taken on January 26, 1911, a cold, cloudy day with frequent showers during the latter part. This view shows the south front and east end of building with a partial

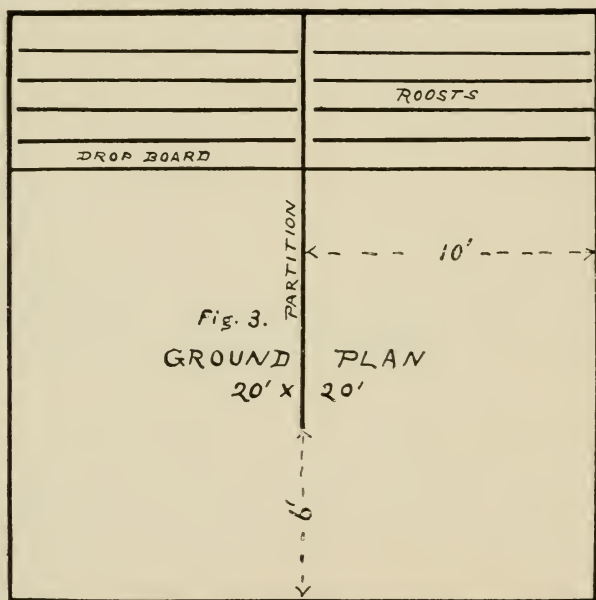

Fig. 19. Ground plan showing dimensions of floor, middle partition and location of roosts and drop boards, Gillette open-air poultry house.

view of the interior. A part of the flock are enjoying the scratching litter which is used in sheltered places OUTSIDE of the house. Mr. Gillette prefers sand for the floors inside of the house and likes to use litter outside. The whole straw, containing the grain just as harvested, is thrown outside of house and the birds work in it most of the day.

"Fig. 21" is from a photo taken on the same day and shows a fine lot of sturdy White Plymouth Rock breeders enjoying a wind-



Fig. 20. From a photograph of Gillette open-air poultry house. View shows east end and south front and a partial view of interior. Flock is scratching in litter outside of house.



Fig. 21. Windbreak of corn stover used with Gillette houses at Sugar Brook Farm, Central Village, Conn. Fine outdoor exercise for the breeders in winter.

break of corn stover stacked against a wire fence. In this sheltered place the fowls get abundant outdoor exercise and it helps greatly in getting well-fertilized strong-germed eggs. Mr. Gillette tells me that he is a great believer in the benefits from this sort of exercise and he plans each fall to have either a straw stack or stover stack for each houseful to work about. It certainly beats working in litter indoors where the fowls kick up a great dust to the injury of their breathing apparatus. The outdoor litter is washed by the rain, dried and sweetened by the sun and so kept sweet. They have but little heavy snow in this part of Connecticut and the fowls can enjoy the outdoor straw stack and litter throughout the winter. Although the houses are not very far apart and there are 150 breeders allowed to each house the flocks do not mix to any great extent, not enough to cause any trouble.

“Fig. 22” shows a row of six Gillette houses on the Sugar Brook Farm range for breeding stock and although taken in bad weather the birds will be seen at work outside the houses. This open-front house is a practical one and appears to be well adapted to free range work with poultry on a large plant. If I were operating I would not bother with the cloth screen or curtain.

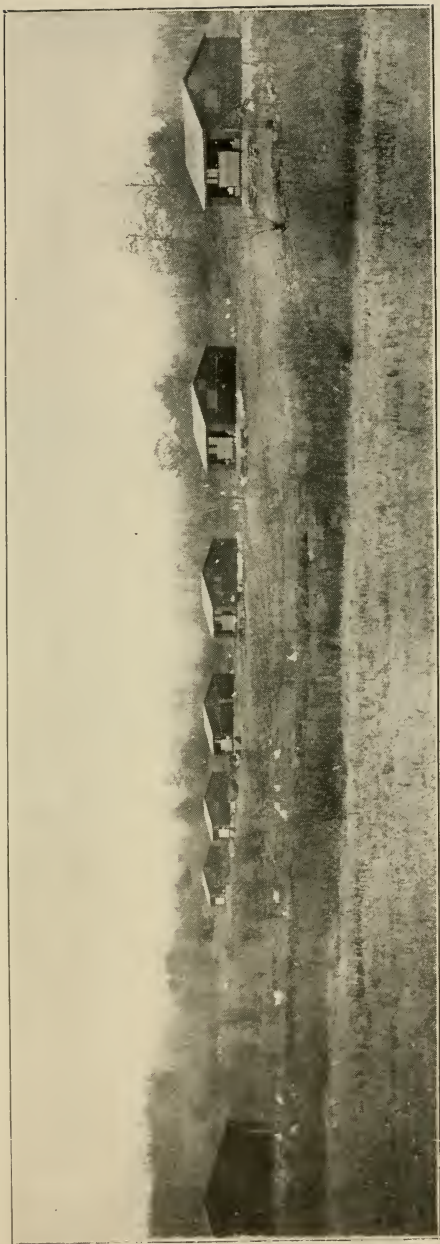

Fig. 22. Row of six Gillette houses on the open range for breeders, Sugar Brook Farm.



Woods' open-air poultry house, 10x16 ft., portable colony type as used by Wozelma Farms Producing Company, Silver Lake, Mass. (Photo by John E. Zeller.)

## CHAPTER VIII.

### H. H. Stoddard's Open-Air Cage Roost



WHEN KEEPING POULTRY in a warm climate it is only a short step from open-front housing to no house at all or to simply a roofed shelter. The open-front house will give excellent service where the summers are hot and the winters are cold or wherever the climatic conditions and variations are such that a house is needed. It has been successfully used in the far north and the far south, but for the south and for tropical or semi-tropical climates a simple roofed shelter or an entirely open cage roost, depending on the frequency of heavy rains, is the most satisfactory method of protecting roosting fowls.

In most warm climates insect pests abound, especially tick-like bugs and fleas. In the south where the soil is rather sandy, the stick-fast flea is a most pestiferous insect and annoys man and fowl alike. It is almost impossible to keep free of these insect pests when ordinary houses are used. The fleas breed in shaded sandy places under buildings and, once they take up their abode there, moving or burning the building is about the only means of dislodging them.

Frequent moving of roosting quarters and construction that will admit of sunlight and fresh air penetrating to all parts of the shelter or coop is the best method of protecting the fowls against these insect pests.

Where rain storms are common and the rainfall heavy, some sort of roofed shelter should be provided. All that is necessary are roosts about 18 inches above the ground, enclosed in wire netting and a not too high roof to keep off the rain. See "Stoddard's Bower." Fig. 23.

H. H. Stoddard, of Riviera, Texas, has devised a cage roost that has proved most satisfactory poultry quarters in the warm dry Gulf coast section of Texas. These consist of cages, of one inch mesh poultry netting, containing roosts. These cages may be built any shape or dimensions desired or found most convenient. They should be made easily movable and with as little woodwork as possible.

The cage roost is designed to provide entirely open-air sleep-

ing quarters. there is no roof, and at the same time to protect the fowls from coyotes, owls, and other night marauders.

Mr. Stoddard says that the heat of southwest Texas is steady and prolonged rather than excessively severe. He finds that cage roosts are particularly well suited to the climatic conditions. Long heavy rains are not common. When it does rain everything dries quickly and looks the brighter and better for it. Fowls roosting



Fig. 23.—H. H. Stoddard's "Bower" for poultry in the Southwest. This is simply a roofed shelter for the roosts and is surrounded by hexagon poultry wire.

out in heavy rainfall quickly dry out bright and happy. He considers the cage roost a perfect success.

Fig. 24 shows frame for a triangular cage roost. This frame is to be covered entirely, sides, ends, and bottom, with one inch mesh poultry netting. It should be provided with a wire door in front. Fig. 25 shows frame for a hexagon cage roost, which can easily be rolled from one location to another. This also is in-



tended to be provided with a door and covered entirely with one-inch mesh poultry netting.

All cages can be made small as compared to ordinary poultry houses. They need not be over four to six feet high. The roosts need not be over eighteen inches from the ground. The fowls are shut out of the cage in the day time, as it is only designed to afford them safe roosting quarters.

Nests elevated on posts or "stilts" may be placed about the poultry runs. These nests should be simple, easily cleaned, roofed boxes.

Mr. Stoddard recommends making these cage roosts in any form which may be convenient, triangular, cylindrical, square, or hexagon. Writing about the cage roost, he says:

"These cages can be moved and partly or completely inverted

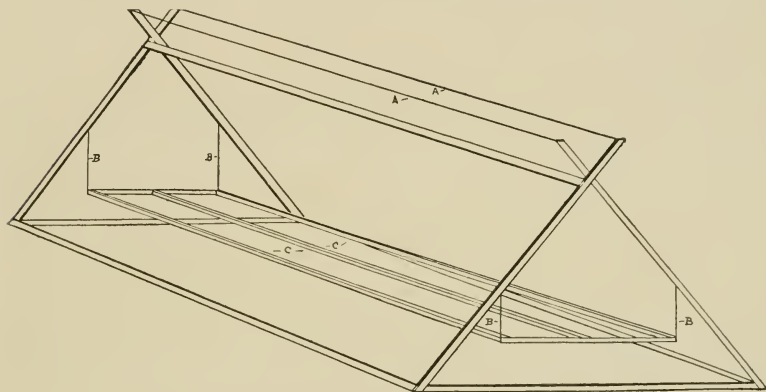

H. H. STODDARD'S WIRE CAGE ROOST.

Fig. 24.—H. H. Stoddard's wire cage roost. This is diagram for the "A" or triangular cage roost and shows construction of frame. The frame is to be entirely covered, top, sides, ends and bottom, with 1-inch mesh hexagon wire poultry netting, A, A, are telephone wires to support edge of wire netting, B, B, are wires to support the roosts. C, C, are the roosts. Front roost should be provided with a wide door.

each day to permit the sun to strike the under side of the perches, an advantage the usual roost does not possess. There is the very minimum of woodwork to harbor parasites or any disease germs.

"Imagine the luxury of seeing rows of fowls clean and fresh looking on their perches, with no tainted quarters and no more possibility of inhaling the smallest quantity of second-hand air than a robin or blackbird in a tree. It is ideal. A soaking rain

seems to do them good. It is true that they look bedraggled and sorry enough while it is actually raining, but it is wonderful how quickly they get in full dress uniform after a storm, and their combs, wattles, and plumage look as fresh and bright as if prepared with care for the exhibition coop. I have found that heavy and prolonged rain does not check laying in the least. The average number of eggs during a rainy spell and several days following, was exactly the same as before it, although we had  $3\frac{1}{2}$  inches of rain in 36 hours. Rain on the birds is natural. The skin and feathers get into a better condition and look fresher and more lustrous, just like the wild birds. The oil gland secretes normally and copiously and the birds use it more and make their toilet with

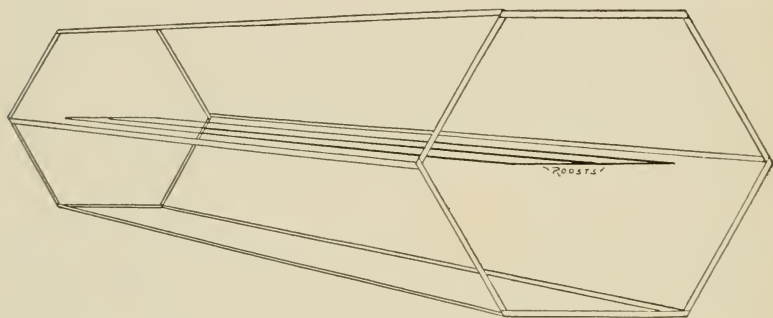

H. H. STODDARD'S WIRE CAGE ROOST.

Fig. 25.—Diagram showing frame for a hexagon shaped Stoddard cage roost. This frame is to be entirely covered with 1-inch mesh poultry netting and to be provided with a wide door in front.

evident enjoyment and good results, whereas, as my readers have noticed, when kept under a roof, this gland is often partially or completely atrophied and useless, its contents being solidly caked, the skin dry and harsh and the plumage dull. Nature knows what she is about. You cannot thwart her with impunity. Fowls that are under a roof all night when it rains never look as clean and healthy and never move about the next day with the vigor and sprightliness of the 'back to nature' birds."

No house cleaning or whitewashing is necessary where cage roosts are used. Where heavy rains occur frequently during the "wet season" I should prefer a roost that has a roof to afford some protection from the rain. It may not be absolutely necessary, but

it is not contrary to nature. The fowls are confined in the cage roost and they cannot get out to seek shelter when heavy rains come. If they were free to do as they chose, they would in all probability seek a sheltered roost in a thick foliated tree on the approach of a heavy rain storm. Occasional heavy rains would do no harm but I should not want to expose my flocks to frequent successive heavy rain storms. It is possible to have too much of a good thing.



Portable Tolman pattern open-front house, 6 ft. wide by 10 ft. deep, built on skids. Used for small chicks by Wozelma Farms Producing Company, Silver Lake, Mass. (Photo by John E. Zeller.)

## CHAPTER IX.

### The Tolman House



THE TOLMAN Fresh-Air House was invented and promoted by Joseph Tolman, of Rockland, Mass., one of the leading pioneers in the development of open-front poultry houses. This house has a double pitch roof with the long slope of roof to the south and the highest point of the roof directly in front of the roosts. It has an entirely open front. The usual dimensions for Tolman houses are, sill measurement: 8 feet wide by 14 feet deep; 10x16 feet, and 14x24 feet. Height at rear, 5 feet from sill, at peak 8 feet from sill, in front 3½ feet from sill, for the smaller houses. The large house has proportionately higher stud. The Tolman house is an excellent house and I used two of them several years in Middleton, Mass., with satisfactory results. Tolman's own story as told in March, 1911, American Poultry Journal, is interesting, here it is as told by himself:

*Fresh-Air Poultry Houses* by Joseph Tolman

"The first eight years of my work in the poultry business was with the closed type of poultry house, and I met with very poor results. Then it was no uncommon thing for me to take hatch after hatch out of my incubators, place the chicks in the brooder yard, in less than three weeks, carry them out again in pails and bags, losing practically the whole hatch, for those that lived would be very poor specimens. Perhaps these poor results cannot be wholly attributed to the manner of housing, yet, from results I have obtained since using my fresh-air houses, I am convinced that most of the trouble was due to close housing of my breeding stock.

"When we stop to think of the closed houses, poorly ventilated and full of stale, foul air, that the majority of poultrymen used for poultry a dozen years ago, we should not be surprised at the frequency with which diseases like roup, diphtheria, tuberculosis, cholera, etc., developed in closed-house flocks. It is a fact that breeding fowls have been so weakened in vitality and disease-resisting power through lack of fresh air, particularly at night, that it has been almost impossible to raise their chicks.

"My first open-front or fresh-air houses were used during the severe cold winter of 1904 and 1905, and remarkably good results

were obtained. Perhaps readers will be interested to know what led me to develop my fresh-air poultry house. During the spring of 1903, Dr. Prince T. Woods visited a number of poultry plants in my neighborhood, where at that time very unsatisfactory results were being obtained. Post-mortem examinations made on a great many birds of various ages led him to believe that an abundance of fresh air in the poultry houses night and day was what was most needed to put the stock in better condition. Acting on his advice, I took the windows out of my poultry houses at once and kept them out until late fall. Seeing a marked change in the



Group of large Tolman houses on plant of Joseph Tolman, Rockland, Mass. (Photo by Dr. Woods.)

health and vigor of my birds, and knowing the remarkable results being obtained in the treatment of the diseases of human beings by treating them in open-air sleeping rooms, I felt sure that in order to get best results with my breeders I needed to keep the poultry house windows wide open all winter. This was the winter of 1903 and 1904, and now after eight winters of open-air poultry housing I could not be induced to return to old-fashioned closed poultry buildings. I am convinced that open-front, fresh-air poul-

try buildings are the only desirable type for the successful housing of breeding and laying stock.

"In 1903-04, although the three houses I used for breeders were not well adapted to such exposure to the elements in severe winter weather, I obtained fine results. The egg yield from 150 Light Brahmas during the coldest months was from 50 to 60 per cent. I was able to hatch from 55 to 65 per cent of the total number of eggs placed in the incubators, and the chickens were large, strong and vigorous. That spring (1904) I had a very small death rate among my chickens and was greatly encouraged.



Tolman open-air roost for growing chicks and surplus cockerels, as used on Tolman fresh-air poultry plant, Rockland, Mass. (Photo by Dr. Woods.)

"The three houses that I made this test with were 20x10 feet, with double pitch roof, side posts 5 feet, two 12-light windows on south side. These were run with windows wide open day and night. During a heavy snow storm the snow drifted into the house so that it had to be shoveled out and to overcome this I designed that fall what is now widely known as the Tolman fresh-air poultry house. While experimenting, and to get actual fresh-air, open-front houses quickly and at least expense, I swung these 20x10-

foot houses around with the 10-foot end facing south, put back the windows and tore out the south end of the building, covering the opening with wire only, and placed the roosts in the north end of the building. These radical open-front houses gave good results, much better than I had ever had in closed houses, but were not as comfortable in severe weather as the Tolman house. See illustration showing house as operated with end torn out; these buildings were used successfully for several winters.

“The improved Tolman house which I have finally adopted as



Radical fresh-air methods employed on the plant of Joseph Tolman, Rockland, Mass. This is an early type of fresh-air building successfully used through several winters. It is an ordinary double-pitch roof building 10 feet wide by 20 feet deep, with the south end torn out and the opening closed only by wire netting. Roosts are in the north end. This building proved better for the fowls than the closed house.

the standard type of poultry building is so well known now that it does not need a full description here. These houses are hip-roofed with the long reach of roof to the south and are built 10 to 14 feet wide and from 16 to 24 feet deep. The front is always open and covered only with wire netting. No curtains are used. See illustration from photographs of one of my first improved pattern Tolman houses. I believe that in fresh-air houses of this type the fowls are much more comfortable than in buildings of other types, and they are protected at all times from the ill effects of weather changes. Fowls housed in these open-front houses show



practically no check in egg yield, no matter how severe the winter weather changes may be.

“The fresh-air house is always dry and comfortable. In closed poultry buildings in severe cold weather moisture collects on the walls which makes the house very uncomfortable. The dampness and lack of fresh air in a closed house, particularly the foul night air that is breathed over and over again, causes fowls to contract colds which develop into roup or other contagious diseases. Dampness and bad air also lead to frosted combs and wattles. These conditions of frost, dampness and insufficient fresh air are eliminated in my fresh-air type of poultry houses.

“In a fresh-air house the fowls have an abundance of pure, fresh



Modern Tolman house of the improved open-front or fresh-air type as used by Joseph Tolman, Rockland, Mass.

breathing air at all times, direct from outdoors, night and day. This insures healthy fowls and freedom from infectious ailments common to flocks housed in closed buildings. A house 10x16 feet will accommodate 40 breeders and one 14x24 feet will house comfortably 100 breeders. This type of building is comfortable for the fowls at all seasons of the year and the air in them is always alive and fresh, never dead and foul as it often is in a closed building. The dry, live air in the open-front house is invigorating and the fowls enjoy their quarters both night and day. In houses

of the fresh-air type you never get the deadly chill that is common to a closed house in winter. Floor and litter keep dry longer and keep sweeter than in closed houses. Though the front is always open, the house is not a cold one in winter and is much warmer than a shed-roofed building.

"As to results in open-air houses I do not believe that they can be duplicated in buildings of the closed type. Reports from all over the country for several years past from users of open-front poultry buildings show better health of the breeding stock, better egg yield, better fertility, and better chicks from the eggs used for hatching. I have had remarkable success and attribute it chiefly to open-air housing of both breeding and growing stock. Six hundred White Plymouth Rocks were wintered from October 1 to March 1 with the loss of only six birds, four of these being crop-bound from eating straw litter. These birds gave a 60 per cent egg yield in December and the fertility ranged from 75 to 85 per cent, with excellent hatches.

"Eight years ago, after eight years of experience with poultry in closed buildings, I was nearly down and out. Adopting fresh-air methods put me on my feet again and enabled me to make a success of my poultry keeping. Now, after eight winters of fresh-air housing of breeding and laying stock and fresh-air rearing for the young flocks I am planning to build more open-front buildings and a large fresh-air brooding system. Two seasons ago I put in a 600-egg Hall mammoth incubator and have shipped chicks all over the country that have made good by developing husky, vigorous breeding stock. This season the demand for day-old chicks has been so great that I have been unable to fill many orders and am now preparing to install another mammoth incubator of the same make. Fresh-air methods made this possible for me."











